

# DIO<sup>o</sup>

## IMPLANT

## SYSTEM

Catalog 2009

**Introduction** Vision, Product Distinctions, DIO Fixture Diagram

**Implant System** SM System, Internal System, External System, ProTem/Secure System, Surgical Kits

**Dental Products** Implant Surgical Devices, Handpiece(Low/High speed handpiece),  
Dental Materials, Sterilizer, Membrane, Bone Material, Toothpaste

# Vision



"DIO IMPLANTS, leading the way to tomorrow's future."

In 1983, DIO established itself through customer centric thinking and cutting edge development to create a dynamic product offering that include: dental implants, dental equipment, dental practices, toothpaste, and surgical stent businesses.

DIO has continued to grow and develop these products and businesses interests to establish their presence in the domestic market and beyond to over 60 countries; DIO is listed on the Korean Stock Exchange and is poised to become a world leader in its field

DIO's product development focuses on the customer needs and satisfaction. DIO's development philosophy is based upon the principle of customer centric thinking: our customers are our business partners. Through this partnership we will become a global leader by utilizing the best in cutting edge technology and best in human resources, DIO will always be in "THE BUSINESS OF HUMAN HEALTH AND HAPPINESS."



# Contents

## Introduction

Vision .....	005
Product Distinctions .....	008
DIO Fixture Diagram .....	010

## Implant System

### SM System

SM-Submerged / Extra Wide

System Flowchart .....	014
Implants/Healing Abutments .....	017
(Submerged, Extra Wide)	
BioTite-H, Extra Wide-H .....	018
Restorative Products .....	025
Surgical Kit	
Master Surgical Kit .....	039
SM/SM Int. Surgical Kit .....	040
Site Preparation (SM) .....	047
SM Extra Wide Surgical Kit .....	048
Site Preparation (Extra Wide) .....	049

### External System

SM-External / FSN / FTN

System Flowchart .....	094
Implants/Healing Abutments .....	098
(SM-External, FSN, FTN)	
Restorative Products .....	103
Surgical Kit	
Master Surgical Kit .....	119
Site Preparation (SM-External) .....	125
FSN Surgical Kit .....	126
FTN Surgical Kit .....	127
Site Preparation (FSN) .....	133
Site Preparation (FTN) .....	133

### Internal System

SM-Internal / IFI / PSI

System Flowchart .....	052
Implants/Healing Abutments .....	057
(SM-Internal, IFI, PSI)	
Restorative Products .....	065
Surgical Kit	
Master Surgical Kit .....	076
SM / SM Int. Surgical Kit .....	077
Site Preparation (SM-Internal) .....	083
IFI/SM Surgical Kit .....	084
PSI Surgical Kit .....	085
Site Preparation (IFI) .....	091
Site Preparation (PSI) .....	091

### ProTem/Secure System

Post / Ball Type

System Flowchart .....	136
Post Type .....	138
ProTem/Secure-H(Post) .....	139
Ball Type .....	140
ProTem/Secure-H(Ball) .....	140
Surgical Kit	
ProTem/Secure Surgical Kit / Site Preparation .....	142
Surgical Instruments .....	142



## Surgical Kits

Bone Expander Kit .....	145
Sinus Lift Kit .....	146
Osteotome Kit .....	147
Prosthetic Kit .....	148

## Dental Products

Implant Surgical Devices .....	152
Handpiece(Low speed handpiece) .....	154
Handpiece(High speed handpiece) .....	155
Dental Materials .....	156
Sterilizers .....	156
Membrane .....	156
Bone Material .....	157

## Product Distinctions

### 1 Brushite (CaP) Coating



Created from a calcium and phosphate solution, the external surface of the implant is treated via electrochemical process which allows the Brushite Coating provides an ultrathin  $15 \pm 5\mu\text{m}$  surface that is also highly bio-compatible.

Brushite's increased calcium concentration promotes the speed of formation of new tissue. Brushite's organic environment supports melting and fine absorption. 6-12 weeks after implant placement, the coating remains intact and secure. Brushite's regenerative environment is conducive to fine absorption.

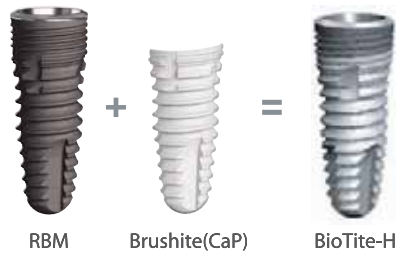

- Early and/ or immediately loading
- Higher success rate regardless of bone type
- Sinus elevation
- Low bone density whereby predicted micromotion
- Higher rate of bone implant contact(Brushite 73%, RBM 50%)

### 2 No-mount system



- The No-Mount System alleviates the pain and hassle of mount disassembly during surgery.
- The direct path connection increases accuracy by enacting an exact fit, resulting in an overall reduction in surgical time.

### 3 Torx Connection(Internal)



Traditional internal structures capacity has a tendency for torque loss due to fatigue. Our Torx Connection consistently provides resistance fatigue against higher torque provided by its design and structure.

Company	DIO	"A"	"B"	"C"	"D"	"E"	"F"
Maximum Torque (Ncm)	112,8 (Torx)	91,7	107,9	49,1	75,5	58,9	68,7

## Product Distinctions

### 4 Rotation Stopper

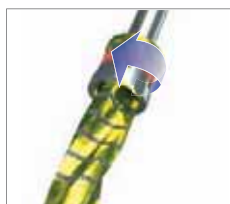

■ Narrow   
 ■ Regular   
 ■ Wide

Rotation stopper provides smooth and simple mounting operation. Rotation stopper increases control during surgery and reduces instrument related bone damage.

### 5 Torx Abutment Screw



Traditional Hex configuration abutment screws have an average tolerance of 35 Ncm. Additional torque can subject to screw to distortion. DIO Torx Abutment screws have much high maximum tolerances and still remain undistorted after unscrewing.

Torx & Hex Abutment Screw maximum tolerances

DIO Torx Abutment Screw		Hex Screw
<b>Narrow</b> Dia, 1,3	Max, 60–65 Ncm Screw fracture occurs Screw removal possible	Max, 43–46 Ncm Hex wears and tears Screw removal difficult.
<b>Regular</b> Dia, 1,5	80–85 Ncm Screw fracture occurs Screw removal possible	

### 6 Cleansing System

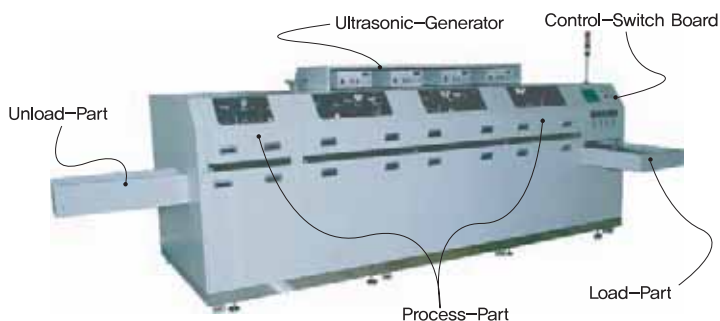

Ultrasonic Vacuum Cleanser, the vacuum drier function coupled with the ultrasonic cleaning function provides residue free surfaces from your products as well as superior safety.

Defective implant cleansers in the operating area can result in contamination and infection. DIO Implant is dedicated to maintaining the quality of its ultrasonic cleanser.

Analysis of foreign substances on fixture by company.

Company	Package Contents	Foreign Contents
DIO	3EA	C, O, Ti
"A"	3EA	C, O, S, Ca, Ti
"B"	3EA	C, O, S, Si, Fe, Mg, Cl, Ca, Zn, P, Ca, Al, Ti
"C"	3EA	C, O, S, Si, Ca, Zn, Na, K, Mo, Al, Ti

## DIO Fixture Diagram

(Unit : mm)

SM System		Internal System		
SM-Submerged	SM-Extra-Wide	SM-Internal	IFI	PSI
 <p>Dimensions: 0.3, Ø3.8, Ø4.1, L, Ø2.4, Ø2.6, Ø3.3, Ø3.6</p>	 <p>Dimensions: Ø5.9, L, Ø3.8</p>	 <p>Dimensions: 2.0, Ø4.8, Ø3.8, L, Ø2.4, Ø3.3</p>	 <p>Dimensions: Ø4.8, C, L, Ø2.8, Ø3.5</p>	 <p>Dimensions: Ø4.8, C, L, Ø3.0, Ø3.5</p>
L : 8 / 10 / 12 / 14	L : 6 / 8 / 10	L : 8 / 10 / 12 / 14		
 <p>Dimensions: 0.3, Ø4.5, Ø5.0, L, Ø3.0, Ø3.5, Ø4.0, Ø4.5</p>	 <p>Dimensions: Ø6.4, L, Ø4.3</p>	 <p>Dimensions: 2.0, Ø4.8, Ø4.5, L, Ø3.1, Ø4.0</p>	 <p>Dimensions: Ø4.8, C, L, Ø3.45, Ø4.1</p>	 <p>Dimensions: Ø4.8, C, L, Ø3.45, Ø4.1</p>
L : 8 / 10 / 12 / 14	L : 6 / 8 / 10	L : 8 / 10 / 12 / 14		
 <p>Dimensions: 0.3, Ø5.3, L, Ø3.6, Ø4.8</p>	 <p>Dimensions: Ø6.9, L, Ø4.8</p>		 <p>Dimensions: Ø4.8, C, L, Ø4.1, Ø4.8</p>	 <p>Dimensions: Ø4.8, C, L, Ø4.15, Ø4.8</p>
L : 8 / 10 / 12 / 14	L : 6 / 8 / 10	L : 8 / 10 / 12 / 14		
		 <p>Dimensions: 2.0, Ø6.5, Ø5.3, L, Ø4.0, Ø4.8</p>	 <p>Dimensions: Ø6.5, C, L, Ø4.1, Ø4.8</p>	 <p>Dimensions: Ø6.5, C, L, Ø4.2, Ø4.8</p>
		L : 8 / 10 / 12 / 14		



DIO Fixture Diagram

(Unit : mm)

External System			ProTem/Secure System	
SM-External	FTN	FSN	Post	Ball
L : 8 / 10 / 12 / 14	L : 7 / 8.5 / 10 / 11.5 / 13 / 15		L : 10 / 12 / 14	
L : 8 / 10 / 12 / 14	L : 7 / 8.5 / 10 / 11.5 / 13 / 15		L : 10 / 12 / 14	
L : 8 / 10 / 12 / 14	L : 7 / 8.5 / 10 / 11.5 / 13 / 15		L : 10 / 12 / 14 / 16	
	L : 8.5 / 10 / 11.5 / 13 / 15			



# SM

## SM Implant System SM-Submerged / Extra Wide



System Flowchart .....	014
Implants/Healing Abutments .....	017
(Submerged, Extra Wide)	
BioTite-H, Extra Wide-H .....	018
Restorative Products .....	025
Surgical Kit	
Master Surgical Kit .....	039
SM/SM Int. Surgical Kit .....	040
Site Preparation (SM) .....	047
SM Extra Wide Surgical Kit .....	048
Site Preparation (Extra Wide) .....	049

SM System Flowchart

Cement-Retained Restorations - Solid Abutment, Solid Abutment(II)

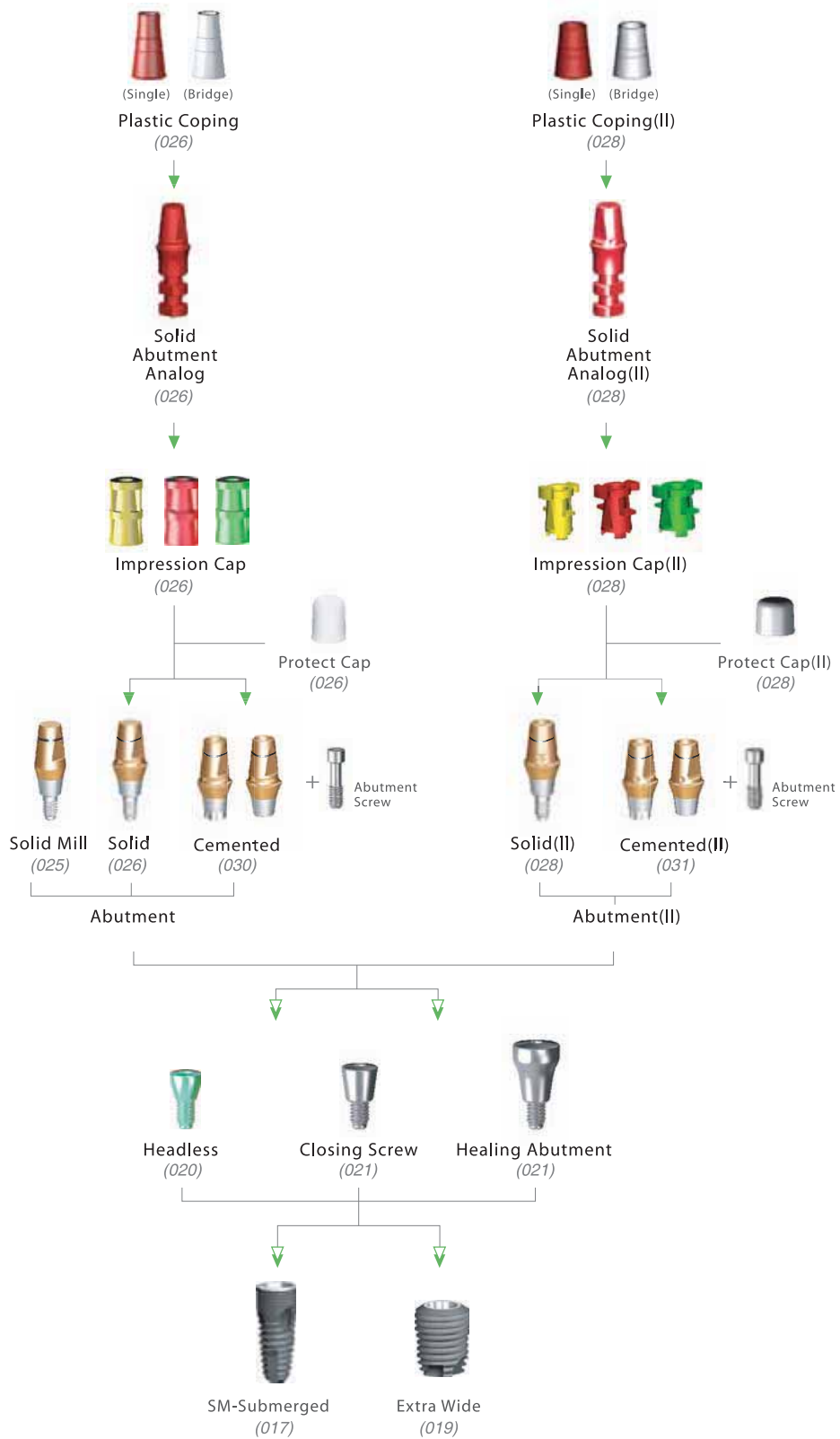

### SM System Flowchart

Cement-Retained Restorations - Cemented Abutment

Cement-Retained Restorations - Angled Abutment

Screw-Retained Restorations - UCLA Abutment

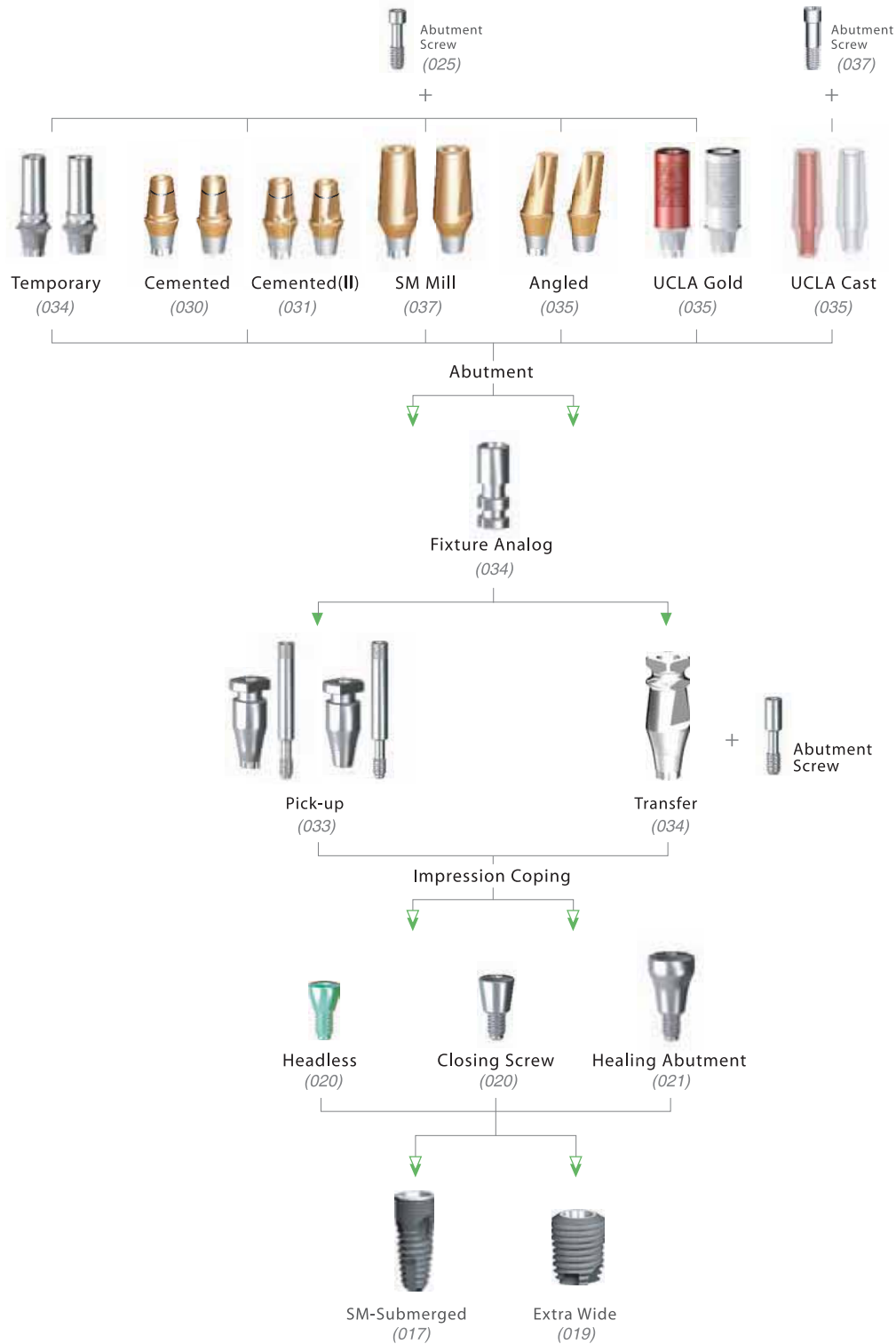

SM System Flowchart  
 Overdenture-Retained Restorations - Ball Abutment

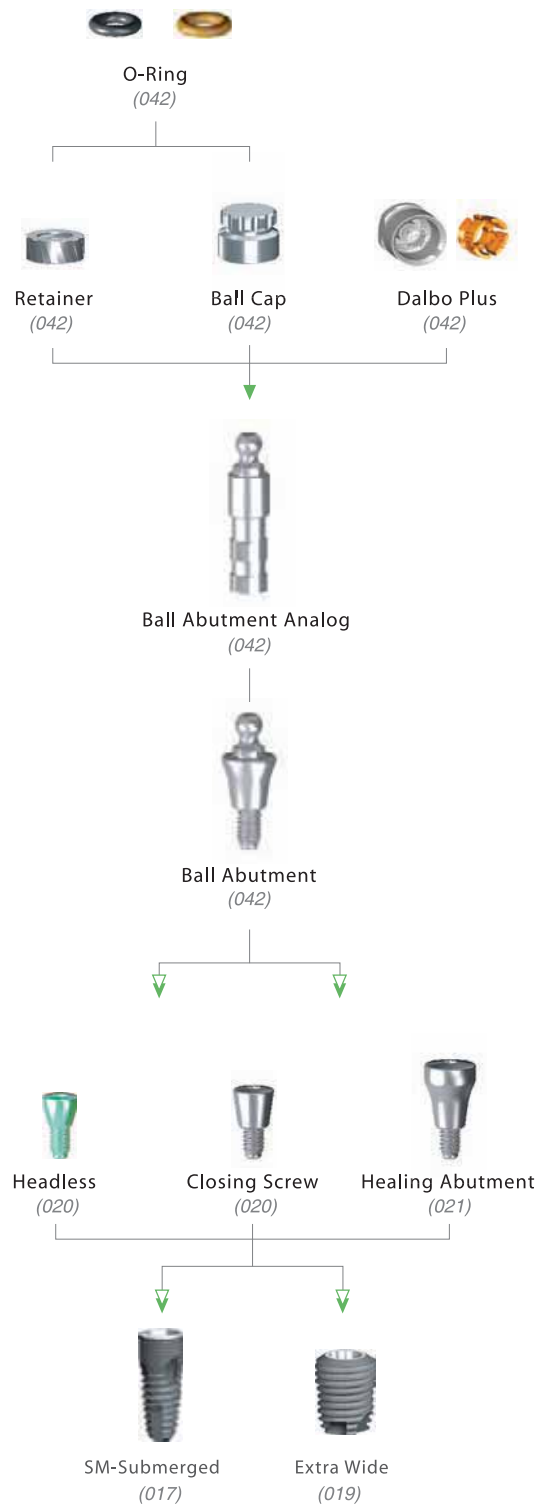

› Internal Torx Connection

Superior to Hex internal connection  
More fixture and driver contact  
No distortion with high torque

› Morse Taper

Abutment is easier to insert along the internal 8° morse tapered surface  
Due to the wider fixture and abutment contact, free from screw loosening

› Platform Switching

"Platform Switching" technique is applied to the design of the implants and abutments to reduce cretal bone loss

› Double Thread

Secure initial seating prevents cortical bone loss

› Root Form Design

Root form design enables excellent stability  
Reduces possibility of touching adjacent teeth root during implant insertion

› Self Tapping

Advanced thread and apex design enable easy self tapping and excellent initial stability in extraction sockets



Narrow



L \ D	Ø3.8
8	SFN 3808
10	SFN 3810
12	SFN 3812
14	SFN 3814

Narrow



L \ D	Ø4.1
8	SFN 4108
10	SFN 4110
12	SFN 4112
14	SFN 4114

Regular



L \ D	Ø4.5
8	SFR 4508
10	SFR 4510
12	SFR 4512
14	SFR 4514

Regular



L \ D	Ø5.0
8	SFR 5008
10	SFR 5010
12	SFR 5012
14	SFR 5014

Wide



L \ D	Ø5.3
8	SFW 5308
10	SFW 5310
12	SFW 5312
14	SFW 5314

Length: 8 10 12 14

SM-Submerged Fixture

N N R R W

Brushite(CaP)  
Coated  
"BioTite-H"

Narrow



L \ D	Ø3.8
8	SFN 3808H
10	SFN 3810H
12	SFN 3812H
14	SFN 3814H

Narrow



L \ D	Ø4.1
8	SFN 4108H
10	SFN 4110H
12	SFN 4112H
14	SFN 4114H

Regular



L \ D	Ø4.5
8	SFR 4508H
10	SFR 4510H
12	SFR 4512H
14	SFR 4514H

Regular



L \ D	Ø5.0
8	SFR 5008H
10	SFR 5010H
12	SFR 5012H
14	SFR 5014H

Wide



L \ D	Ø5.3
8	SFW 5308H
10	SFW 5310H
12	SFW 5312H
14	SFW 5314H

Length: 8 10 12 14



## SM-Extra Wide Fixture

### › Tapered Design

Early loading possible in the initial seating  
 Minimized bone heating  
 Screw pitch: 0,8mm, Thread height: 0,5mm

### › Internal Torx Connection

Superior to Hex internal connection  
 More fixture and driver contact  
 No distortion with high torque

### › No-mount System

Does not require disassembling of mounts during surgical operations  
 Increases convenience and decreases time of surgical operation

### › Convenient Compatibility System

Compatible with the SM Submerge Implant

### › Platform Switching

"Platform Switching" technique is applied to the design of the implants and abutments to reduce cretal bone loss



RBM

Brushite(CaP)  
Coated



"Extra Wide-H"

L \ D	Ø5.9
6	MX 5906
8	MX 5908
10	MX 5910

L \ D	Ø6.4
6	-
8	MX 6408
10	MX 6410

L \ D	Ø6.9
6	MX 6906
8	MX 6908
10	MX 6910

Length: 6      8      10

L \ D	Ø5.9
6	-
8	MX 5908B
10	MX 5910B

L \ D	Ø6.4
6	-
8	MX 6408B
10	MX 6410B

L \ D	Ø6.9
6	-
8	MX 6908B
10	MX 6910B

Length: 8      10

## Headless / Closing Screw

N R W

## Headless



Fixture	Ø3.8	Ø4.1	Ø4.5	Ø5.0	Ø5.3
Code	SSC 3106		SSC 3506		

- Color coded fixtures for easy identification  
Ø3.8, Ø4.1: Blue / Ø4.5, Ø5.0, Ø5.3: Green
- Uses 1,2 Hex Driver
- Package Contents: Headless
- Tightening Torque: 5-8 Ncm

## Closing Screw



C	Fixture	Ø3.8	Ø4.1	Ø4.5	Ø5.0	Ø5.3
1		SSC 3110		SSC 3510		
2		SSC 3120		SSC 3520		

- Closing screw used in case of placing implant deeper than bone level
- Uses 1,2 Hex Driver
- Package Contents: Closing Screw
- Tightening Torque: 5-8 Ncm



# Healing Abutment

N R

## Healing Abutment

- Uses 1,2 Hex Driver
- Package Contents: Healing Abutment
- Tightening Torque: 5-8 Ncm

\* Laser Marking

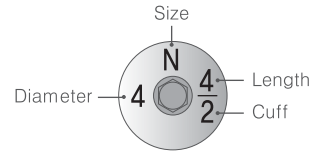

### Narrow



D	Ø4.1		
L \ C	1	2	3
3	SAHN 4113	-	-
4	-	SAHN 4124	-
5	-	-	SAHN 4135
6.5	-	-	SAHN 4136
8	-	-	SAHN 4138



D	Ø5.2		
L \ C	1	2	3
3	SAHN 5213	-	-
4	-	SAHN 5224	-
5	-	-	SAHN 5235
6.5	-	-	SAHN 5236
8	-	-	SAHN 5238

### Regular



D	Ø5.2		
L \ C	1	2	3
3	SAH 5213	-	-
4	-	SAH 5224	-
5	-	-	SAH 5235
6.5	-	-	SAH 5236
8	-	-	SAH 5238

## Healing Abutment

W

Wide

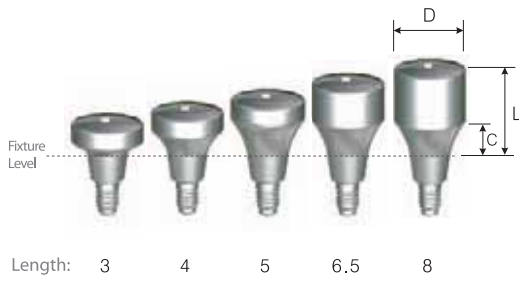

D	Ø6.2		
L \ C	1	2	3
3	SAH 6213	-	-
4	-	SAH 6224	-
5	-	-	SAH 6235
6.5	-	-	SAH 6236
8	-	-	SAH 6238



D	Ø8.2			
L \ C	1	2	3	4
2	SAH 8212	-	-	-
3	-	SAH 8223	-	-
4	-	-	SAH 8234	-
5	-	-	-	SAH 8245



D	Ø9.2			
L \ C	1	2	3	4
2	SAH 9212	-	-	-
3	-	SAH 9223	-	-
4	-	-	SAH 9234	-
5	-	-	-	SAH 9245

## Abutments for SM Implant System



**Ball**  
(038)



**UCLA Cast**  
(036)



**UCLA Gold**  
(036)



**SM Mill**  
(037)



**Angled**  
(035)



**Cemented**  
(030)



**Cemented(II)**  
(031)



**Solid Mill**  
(025)



**Solid**  
(026)



**Solid(II)**  
(028)



**Fixture**

## Abutment Selection Guide

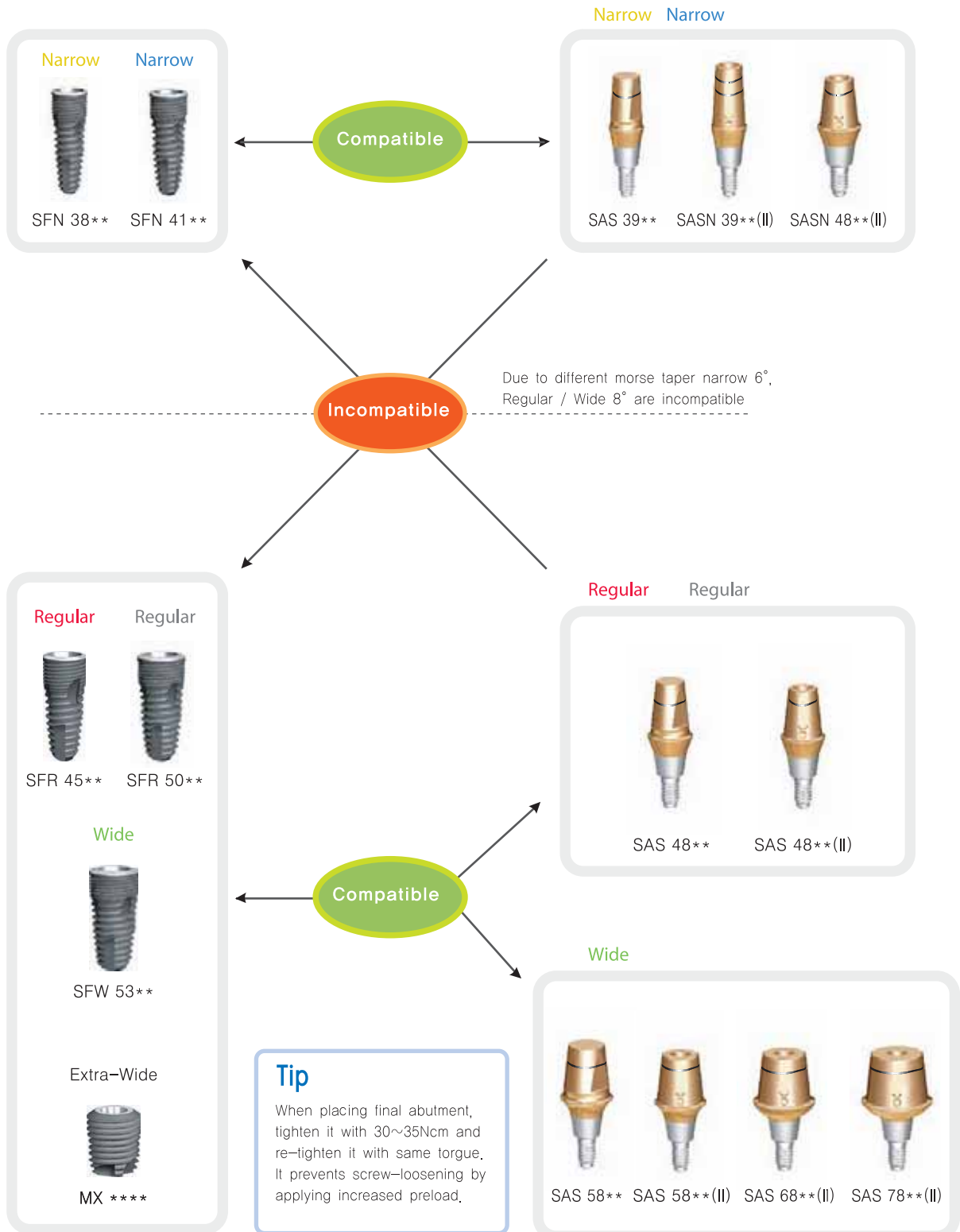

**Solid Mill Abutment**

- Used for standard cement type prosthetic fabrication
- Useful in specialized prosthetics and custom abutments
- Single body abutment and screw construction
- Secure tapered connection construction
- Aesthetically designed gold coloring
- Prosthetic rotation prevention
- Uses Ø3,9, Ø4,8, Ø5,8: Solid Abutment Driver
- Package Contents: Abutment
- Tightening Torque: 35 Ncm

**Narrow**

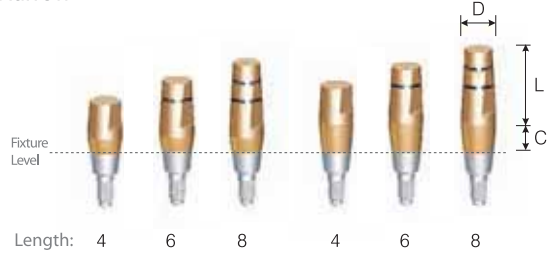

C	L \ D	Ø3.6
1.5	4	SAS 3614
	6	SAS 3616
	8	SAS 3618
3	4	SAS 3634
	6	SAS 3636
	8	SAS 3638

**Regular**

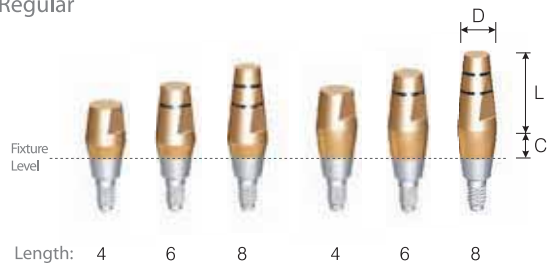

C	L \ D	Ø4.2
1.5	4	SAS 4214
	6	SAS 4216
	8	SAS 4218
3	4	SAS 4234
	6	SAS 4236
	8	SAS 4238

**Wide**



C	L \ D	Ø5.2
1.5	4	SAS 5214
	6	SAS 5216
	8	SAS 5218
3	4	SAS 5234
	6	SAS 5236
	8	SAS 5238

### Solid Abutment

- Used for standard cement type prosthetic fabrication
- Single body abutment and screw construction
- Secure tapered connection construction
- Aesthetically designed gold coloring
- Prosthetic rotation prevention
- Uses Ø3.9, Ø4.8, Ø5.8: solid abutment driver
- Package Contents: Solid Abutment + Protect Cap
- Tightening Torque: 30 Ncm



L	C	D	Narrow		
			Ø3.9	Ø4.8	Ø5.8
4	1		SAS 3914	SAS 4814	SAS 5814
	2		SAS 3924	SAS 4824	SAS 5824
	3		SAS 3934	SAS 4834	SAS 5834
	4.5		SAS 3944	SAS 4844	SAS 5844
	6		SAS 3964	SAS 4864	SAS 5864
6	1		SAS 3916	SAS 4816	SAS 5816
	2		SAS 3926	SAS 4826	SAS 5826
	3		SAS 3936	SAS 4836	SAS 5836
	4.5		SAS 3946	SAS 4846	SAS 5846
	6		SAS 3966	SAS 4866	SAS 5866
8	1		SAS 3918	SAS 4818	SAS 5818
	2		SAS 3928	SAS 4828	SAS 5828
	3		SAS 3938	SAS 4838	SAS 5838
	4.5		SAS 3948	SAS 4848	SAS 5848
	6		SAS 3968	SAS 4868	SAS 5868



### Protect Cap

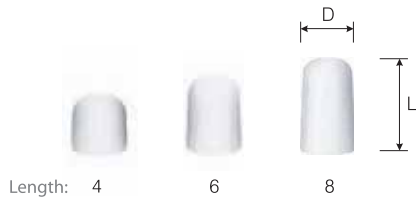

L \ D	Ø3.9	Ø4.8	Ø5.8
4	SASC 3904	SASC 4804	SASC 5804
6	SASC 3906	SASC 4806	SASC 5806
8	SASC 3908	SASC 4808	SASC 5808

- Protects the abutment and keeps foreign particles to a minimum
- Keeps the place of future prosthetic
- Convenient locking mechanism
- Package Contents: Protect Cap

### Impression Cap



L \ D	Ø3.9	Ø4.8	Ø5.8
10	SASI 3910	SASI 4810	SASI 5810

- Used for making impression with abutments
- Simple color coding according to abutment diameter
- 3,9mm: Yellow, 4,8mm: Red, 5,8mm: Green
- Convenient locking mechanism
- Package Contents: Impression Cap

### Solid Abutment Analog

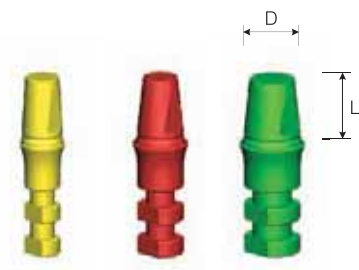

L \ D	Ø3.9	Ø4.8	Ø5.8
4	SASA 3904	SASA 4804	SASA 5804
6	SASA 3906	SASA 4806	SASA 5806
8	SASA 3908	SASA 4808	SASA 5808

- Provides anchor point for fabricating implant prosthetics on working model
- Simple color coding according to abutment diameter
- 3,9mm: Yellow, 4,8mm: Red, 5,8mm: Green
- Package Contents: Solid Abutment Analog

### Plastic Coping



L \ D	Ø3.9	Ø4.8	Ø5.8
10	SASP 3910S	SASP 4810S	SASP 5810S
	SASP 3910B	SASP 4810B	SASP 5810B

- Provides a framework for prosthetic for use with Solid Abutment Analog
- Simple color coding according to type of prosthetic
- Single: Red, Bridge: White
- Convenient locking mechanism
- Package Contents: Plastic Coping

Solid Abutment(II)



		Narrow					
L	C \ D	Ø3.9	Ø4.8	Ø4.8	Ø5.8	Ø6.8	Ø7.8
4	1	SASN 3914(II)	SASN 4814(II)	SAS 4814(II)	SAS 5814(II)	SAS 6814(II)	SAS 7814(II)
	2	SASN 3924(II)	SASN 4824(II)	SAS 4824(II)	SAS 5824(II)	SAS 6824(II)	SAS 7824(II)
	3	SASN 3934(II)	SASN 4834(II)	SAS 4834(II)	SAS 5834(II)	SAS 6834(II)	SAS 7834(II)
	4.5	SASN 3944(II)	SASN 4844(II)	SAS 4844(II)	SAS 5844(II)	SAS 6844(II)	SAS 7844(II)
	6	SASN 3964(II)	SASN 4864(II)	SAS 4864(II)	SAS 5864(II)	SAS 6864(II)	SAS 7864(II)
5.5	1	SASN 3915(II)	SASN 4815(II)	SAS 4815(II)	SAS 5815(II)	SAS 6815(II)	SAS 7815(II)
	2	SASN 3925(II)	SASN 4825(II)	SAS 4825(II)	SAS 5825(II)	SAS 6825(II)	SAS 7825(II)
	3	SASN 3935(II)	SASN 4835(II)	SAS 4835(II)	SAS 5835(II)	SAS 6835(II)	SAS 7835(II)
	4.5	SASN 3945(II)	SASN 4845(II)	SAS 4845(II)	SAS 5845(II)	SAS 6845(II)	SAS 7845(II)
	6	SASN 3965(II)	SASN 4865(II)	SAS 4865(II)	SAS 5865(II)	SAS 6865(II)	SAS 7865(II)
7	1	SASN 3917(II)	SASN 4817(II)	SAS 4817(II)	SAS 5817(II)	SAS 6817(II)	SAS 7817(II)
	2	SASN 3927(II)	SASN 4827(II)	SAS 4827(II)	SAS 5827(II)	SAS 6827(II)	SAS 7827(II)
	3	SASN 3937(II)	SASN 4837(II)	SAS 4837(II)	SAS 5837(II)	SAS 6837(II)	SAS 7837(II)
	4.5	SASN 3947(II)	SASN 4847(II)	SAS 4847(II)	SAS 5847(II)	SAS 6847(II)	SAS 7847(II)
	6	SASN 3967(II)	SASN 4867(II)	SAS 4867(II)	SAS 5867(II)	SAS 6867(II)	SAS 7867(II)

Protect Cap(II)

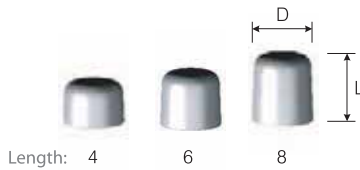

L \ D	Ø3.9	Ø4.8	Ø5.8	Ø6.8	Ø7.8
4	SASC 3904(II)	SASC 4804(II)	SASC 5804(II)	SASC 6804(II)	SASC 7804(II)
5.5	SASC 3905(II)	SASC 4805(II)	SASC 5805(II)	SASC 6805(II)	SASC 7805(II)
7	SASC 3907(II)	SASC 4807(II)	SASC 5807(II)	SASC 6807(II)	SASC 7807(II)

Impression Cap(II)



L \ D	Ø3.9	Ø4.8	Ø5.8	Ø6.8	Ø7.8
10	SASI 3910(II)	SASI 4810(II)	SASI 5810(II)	SASI 6810(II)	SASI 7810(II)

Solid Abutment Analog(II)



L \ D	Ø3.9	Ø4.8	Ø5.8	Ø6.8	Ø7.8
4	SASA 3904(II)	SASA 4804(II)	SASA 5804(II)	SASA 6804(II)	SASA 7804(II)
5.5	SASA 3905(II)	SASA 4805(II)	SASA 5805(II)	SASA 6805(II)	SASA 7805(II)
7	SASA 3907(II)	SASA 4807(II)	SASA 5807(II)	SASA 6807(II)	SASA 7807(II)

Plastic Coping(II)



L \ D	Ø3.9	Ø4.8	Ø5.8	Ø6.8	Ø7.8
10	SASP 3910S(II)	SASP 4810S(II)	SASP 5810S(II)	SASP 6810S(II)	SASP 7810S(II)
	SASP 3910B(II)	SASP 4810B(II)	SASP 5810B(II)	SASP 6810B(II)	SASP 7810B(II)

### Cemented Abutment

- Used for standard cement type prosthetic fabrication
- Secure tapered connection construction
- Aesthetically designed gold coloring
- Prosthetic rotation prevention
- Uses 1.7 Torx Driver
- Package Contents:  
Abutment + Abutment Screw
- Tightening Torque: 35 Ncm



#### Narrow



D		Ø3.9	
L	C	Type	
4	1	Torx	SAC 3914T
	2	Torx	SAC 3924T
	3	Torx	SAC 3934T
	4.5	Torx	SAC 3944T
	6	Torx	SAC 3964T
6	1	Non-Torx	SAC 3914N
	2	Non-Torx	SAC 3924N
	3	Non-Torx	SAC 3934N
	4.5	Non-Torx	SAC 3944N
	6	Non-Torx	SAC 3964N

#### Regular



D		Ø4.8	
L	C	Type	
4	1	Torx	SAC 4814T
	2	Torx	SAC 4824T
	3	Torx	SAC 4834T
	4.5	Torx	SAC 4844T
	6	Torx	SAC 4864T
6	1	Non-Torx	SAC 4814N
	2	Non-Torx	SAC 4824N
	3	Non-Torx	SAC 4834N
	4.5	Non-Torx	SAC 4844N
	6	Non-Torx	SAC 4864N

#### Wide

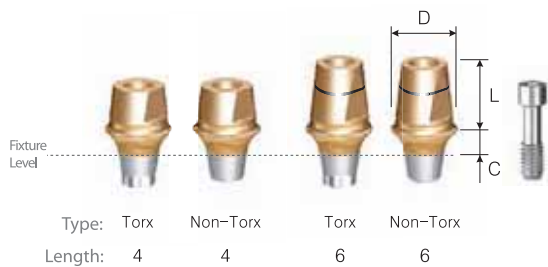

D		Ø5.8	
L	C	Type	
4	1	Torx	SAC 5814T
	2	Torx	SAC 5824T
	3	Torx	SAC 5834T
	4.5	Torx	SAC 5844T
	6	Torx	SAC 5864T
6	1	Non-Torx	SAC 5814N
	2	Non-Torx	SAC 5824N
	3	Non-Torx	SAC 5834N
	4.5	Non-Torx	SAC 5844N
	6	Non-Torx	SAC 5864N

Cemented Abutment(II)

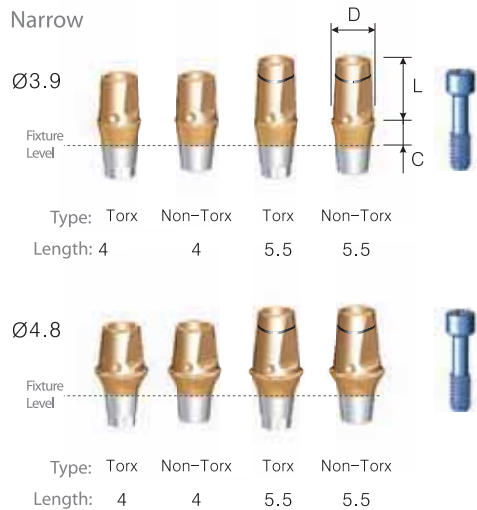

D		Ø3.9		Ø4.8	
L	Type	Torx	Non-Torx	Torx	Non-Torx
4	1	SACN 3914T(II)	SACN 3914N(II)	SACN 4814T(II)	SACN 4814N(II)
	2	SACN 3924T(II)	SACN 3924N(II)	SACN 4824T(II)	SACN 4824N(II)
	3	SACN 3934T(II)	SACN 3934N(II)	SACN 4834T(II)	SACN 4834N(II)
	4.5	SACN 3944T(II)	SACN 3944N(II)	SACN 4844T(II)	SACN 4844N(II)
	6	SACN 3964T(II)	SACN 3964N(II)	SACN 4864T(II)	SACN 4864N(II)
5.5	1	SACN 3915T(II)	SACN 3915N(II)	SACN 4815T(II)	SACN 4815N(II)
	2	SACN 3925T(II)	SACN 3925N(II)	SACN 4825T(II)	SACN 4825N(II)
	3	SACN 3935T(II)	SACN 3935N(II)	SACN 4835T(II)	SACN 4835N(II)
	4.5	SACN 3945T(II)	SACN 3945N(II)	SACN 4845T(II)	SACN 4845N(II)
	6	SACN 3965T(II)	SACN 3965N(II)	SACN 4865T(II)	SACN 4865N(II)

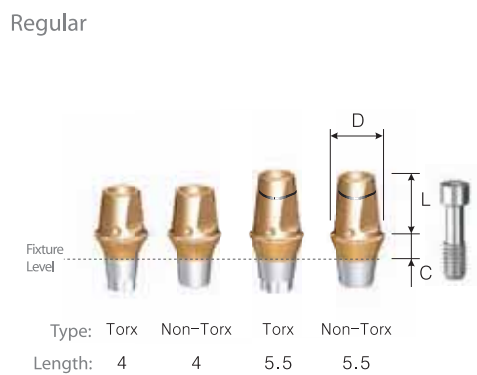

D		Ø4.8	
L	Type	Torx	Non-Torx
4	1	SAC 4814T(II)	SAC 4814N(II)
	2	SAC 4824T(II)	SAC 4824N(II)
	3	SAC 4834T(II)	SAC 4834N(II)
	4.5	SAC 4844T(II)	SAC 4844N(II)
	6	SAC 4864T(II)	SAC 4864N(II)
5.5	1	SAC 4815T(II)	SAC 4815N(II)
	2	SAC 4825T(II)	SAC 4825N(II)
	3	SAC 4835T(II)	SAC 4835N(II)
	4.5	SAC 4845T(II)	SAC 4845N(II)
	6	SAC 4865T(II)	SAC 4865N(II)

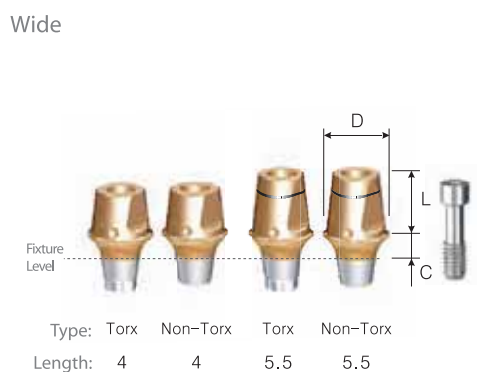

D		Ø5.8	
L	Type	Torx	Non-Torx
4	1	SAC 5814T(II)	SAC 5814N(II)
	2	SAC 5824T(II)	SAC 5824N(II)
	3	SAC 5834T(II)	SAC 5834N(II)
	4.5	SAC 5844T(II)	SAC 5844N(II)
	6	SAC 5864T(II)	SAC 5864N(II)
5.5	1	SAC 5815T(II)	SAC 5815N(II)
	2	SAC 5825T(II)	SAC 5825N(II)
	3	SAC 5835T(II)	SAC 5835N(II)
	4.5	SAC 5845T(II)	SAC 5845N(II)
	6	SAC 5865T(II)	SAC 5865N(II)

Cemented Abutment(II)



D		Ø6.8	
L	C	Type	
		Torx	Non-Torx
4	1	SAC 6814T(II)	SAC 6814N(II)
	2	SAC 6824T(II)	SAC 6824N(II)
	3	SAC 6834T(II)	SAC 6834N(II)
	4.5	SAC 6844T(II)	SAC 6844N(II)
	6	SAC 6864T(II)	SAC 6864N(II)
5.5	1	SAC 6815T(II)	SAC 6815N(II)
	2	SAC 6825T(II)	SAC 6825N(II)
	3	SAC 6835T(II)	SAC 6835N(II)
	4.5	SAC 6845T(II)	SAC 6845N(II)
	6	SAC 6865T(II)	SAC 6865N(II)



D		Ø7.8	
L	C	Type	
		Torx	Non-Torx
4	1	SAC 7814T(II)	SAC 7814N(II)
	2	SAC 7824T(II)	SAC 7824N(II)
	3	SAC 7834T(II)	SAC 7834N(II)
	4.5	SAC 7844T(II)	SAC 7844N(II)
	6	SAC 7864T(II)	SAC 7864N(II)
5.5	1	SAC 7815T(II)	SAC 7815N(II)
	2	SAC 7825T(II)	SAC 7825N(II)
	3	SAC 7835T(II)	SAC 7835N(II)
	4.5	SAC 7845T(II)	SAC 7845N(II)
	6	SAC 7865T(II)	SAC 7865N(II)

**Tip** As post shape of SM Cemented Abutment is same as that of Solid Abutment, taking impression using solid impression cap is possible as in cemented Abutment

**Pick-up Impression Coping**

- Used for pick-up impressions with custom trays
- Uses 1,2 Hex Driver
- Package Contents: Impression Coping + Guide Pin



**Narrow**



D	Ø3.9					
L	7		10		13	
Type	Torx	Non-Torx	Torx	Non-Torx	Torx	Non-Torx
Code	SIP 3907T	SIP 3907N	SIP 3910T	SIP 3910N	SIP 3913T	SIP 3913N

**Regular**



D	Ø4.8					
L	7		10		13	
Type	Torx	Non-Torx	Torx	Non-Torx	Torx	Non-Torx
Code	SIP 4807T	SIP 4807N	SIP 4810T	SIP 4810N	SIP 4813T	SIP 4813N

**Wide**



D	Ø5.8					
L	7		10		13	
Type	Torx	Non-Torx	Torx	Non-Torx	Torx	Non-Torx
Code	SIP 5807T	SIP 5807N	SIP 5810T	SIP 5810N	SIP 5813T	SIP 5813N

### Transfer Impression Coping

- Used for Transfer Type impressions with custom trays
- Enhanced customization after impression made possible by its rectangular construction
- Two-Piece Construction
- Uses 1,7 Torx Driver
- Package Contents: Impression Coping + Screw

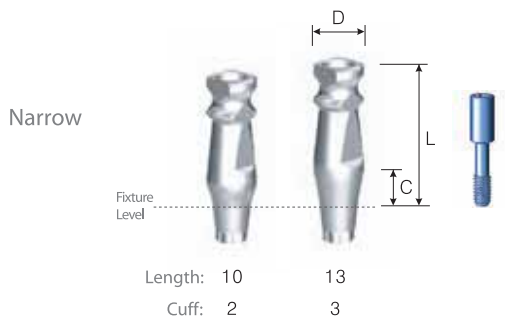

L	C	D	Ø4.1
10	2		SIT 4102T
13	3		SIT 4103T

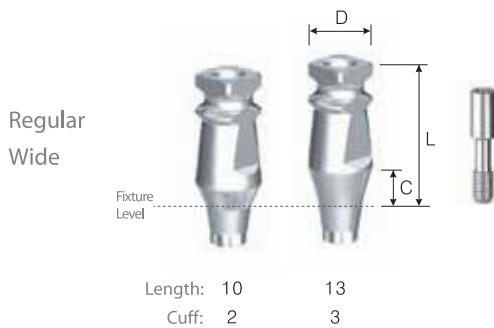

L	C	D	Ø5.2	Ø5.2
10	2		SIT 5202T	
13	3		SIT 5203T	

### Fixture Analog



L	D	Ø3.8	Ø4.5	Ø4.5
12		SAF 3812	SAF 4512	

- Provides anchor point for fabricating implant prosthetics on working model.
- Package Contents: Analog

### Temporary Abutment

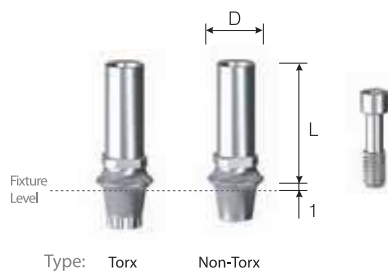

L	Type	D	Ø3.9	Ø4.8	Ø5.8
10	Torx		SAT 3910T	SAT 4810T	SAT 5810T
	Non-Torx		SAT 3910N	SAT 4810N	SAT 5810N

- Used in prosthetic fabrication
- Customizable
- Uses 1,7 Torx Driver
- Package Contents: Abutment + Abutment Screw
- Tightening Torque: 30 Ncm



**Angled Abutment**

- Secure tapered connection construction
- Aesthetically designed gold coloring
- Uses 1,7 Torx Driver
- Package Contents: Abutment + Abutment Screw
- Tightening Torque: 35 Ncm

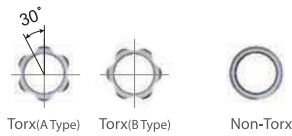

**Narrow**



D		Ø3.9	
C	Angled		
	Type	15°	
1.5	Torx(A Type)	SAA 39115A	SAA 39125A
	Torx(B Type)	SAA 39115B	SAA 39125B
	Non-Torx	SAA 39115	SAA 39125
3	Torx(A Type)	SAA 39315A	SAA 39325A
	Torx(B Type)	SAA 39315B	SAA 39325B
	Non-Torx	SAA 39315	SAA 39325

**Regular**



D		Ø4.8	
C	Angled		
	Type	15°	
1.5	Torx(A Type)	SAA 48115A	SAA 48125A
	Torx(B Type)	SAA 48115B	SAA 48125B
	Non-Torx	SAA 48115	SAA 48125
3	Torx(A Type)	SAA 48315A	SAA 48325A
	Torx(B Type)	SAA 48315B	SAA 48325B
	Non-Torx	SAA 48315	SAA 48325

**Wide**



D		Ø5.8	
C	Angled		
	Type	15°	
1.5	Torx(A Type)	SAA 58115A	SAA 58125A
	Torx(B Type)	SAA 58115B	SAA 58125B
	Non-Torx	SAA 58115	SAA 58125
3	Torx(A Type)	SAA 58315A	SAA 58325A
	Torx(B Type)	SAA 58315B	SAA 58325B
	Non-Torx	SAA 58315	SAA 58325

**UCLA Gold Abutment**

- Used for superior aesthetics and precision
- Secure tapered connection construction
- Gold casting for ultimate customization
- Uses 1,7 Torx Driver
- Package Contents: Abutment + Abutment Screw
- Tightening Torque: 35 Ncm

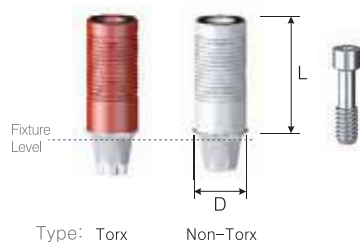

L	D		Ø3.9	Ø4.8	Ø4.8
	Type				
10	Torx		SAG 3910T	SAG 4810T	
	Non-Torx		SAG 3910N	SAG 4810N	

**UCLA Cast Abutment**

- Used for superior aesthetics and customization
- Gold casting for ultimate customization
- Less precise than the UCLA Gold Abutment
- Uses 1,7 Torx Driver
- Package Contents: Abutment + Abutment Screw
- Tightening Torque: 35 Ncm

**Narrow**

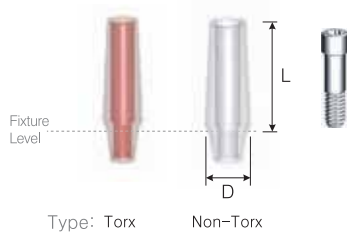

L	D		Ø4.0
	Type		
11.7	Torx		SCA 4014T
	Non-Torx		SCA 4014N

\*Screw: SSC 1808C

**Regular Wide**



L	D		Ø4.5	Ø4.5
	Type			
11.7	Torx		SCA 4514T	
	Non-Torx		SCA 4514N	

\*Screw: SSC 2008C

**SM Mill Abutment**

- Used for when high customization in abutment path and prosthetic margins are needed
- Secure tapered connection construction
- Aesthetically designed gold coloring
- Uses 1,7 Torx Driver
- Package Contents: Abutment + Abutment Screw
- Tightening Torque: 35 Ncm



C	L	Type \ D	Ø4.0	Ø4.5
1.2	10.5	Torx	SMA 4014T	SMA 4514T
		Non-Torx	SMA 4014N	SMA 4514N



C	L	Type \ D	Ø5.0	Ø5.5
2.3	10	Torx	SMA 5015T	SMA 5515T
		Non-Torx	SMA 5015N	SMA 5515N



C	L	Type \ D	Ø6.0	Ø6.5
2.3	10 / 13	Torx	SMA 6015T	SMA 6513T
		Non-Torx	SMA 6015N	SMA 6513N

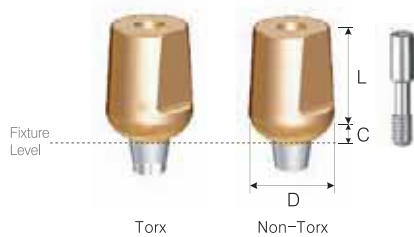

C	L	Type \ D	Ø7.5
2.3	13	Torx	SMA 7513T
		Non-Torx	SMA 7513N

**Abutment Screw**

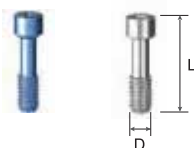

L \ D	Ø1.8	Ø2.0	Ø2.0
8.5	SSC 1808	SSC 2008	
11.5	SSC 1812	SSC 2012	

## Ball Abutment

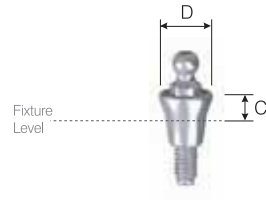

C \ D	Ø3.9	Ø4.5	Ø4.5
2	SAB 3902	SAB 4502	
4	SAB 3904	SAB 4504	

- Used in conjunction with ball type overdenture prosthetic fabrication
- O-Ring Types
  - Black: Laboratory type
  - Orange: Clinical type
- Uses O-Ring for ball retention
- Up to a 20° compensation
- Uses ball abutment driver
- Package Contents: Abutment + O-Ring
- Tightening Torque: 35 Ncm

## Ball Abutment Analog



L \ D	Ø3.5	Ø3.5	Ø3.5
10	SABA 3510		

- Provides anchor point for ball abutment on working model
- Package Contents: Analog

## Dalbo Plus



	Narrow	Regular	Wide
Code	DBPM 201		

- Titanium housing with 2 stage construction
- Rated for up to 10,000 uses with minimum abrasion to the ball abutment and to the insert
- Simple and convenient retention
- Up to 20° in insertion angle flexibility
- Compatible with all DIO Implant systems

## Retainer

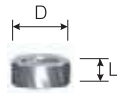

L \ D	Ø5.0	Ø5.0	Ø5.0
2	RT 0502		

- Packing Contents: Retainer + O-Ring

## Ball Cap

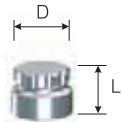

L \ D	Ø5.0	Ø5.0	Ø5.0
4	BC 5004		

- Superior retention and removability
- Package Contents: Ball Cap + O-Ring

## O-Ring

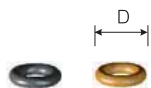

Type \ D	Ø4.5	Ø4.5	Ø4.5
Black	OR 0450B		
Orange	OR 04500		

- Black: Laboratory used for fabrications with high retention
- Orange: For clinical use(over 6 Ncm)
- Package Contents: O-Ring (1 piece)

# Master Surgical Kit

## SM Implant System(SM-Submerged)

SM System

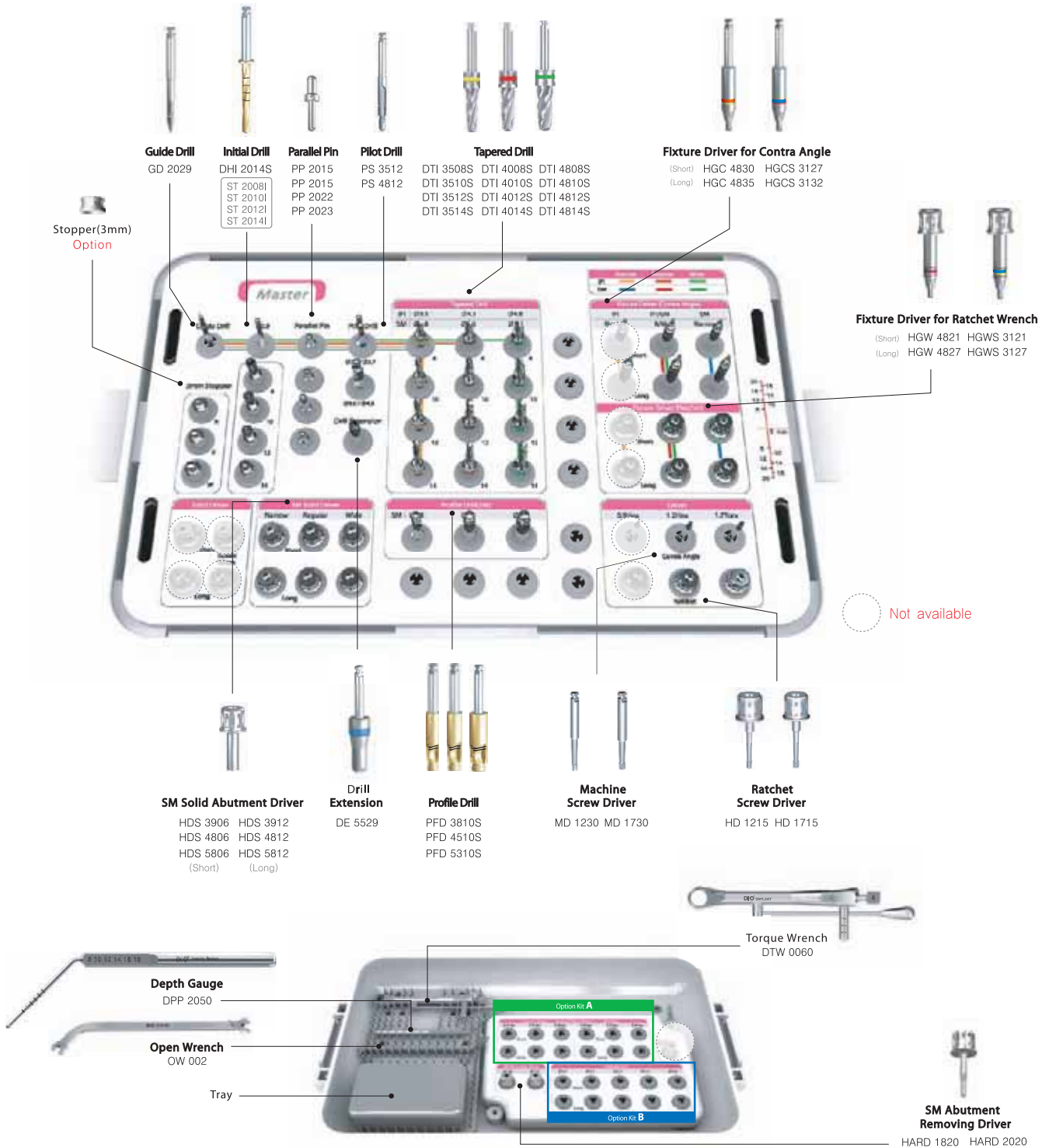

### Master KIT Option

Option Kit A	Fixture Driver for Contra Angle	Fixture Driver for Ratchet Wrench
	HGC 3524 HGC 4024 HGC 5024 HGC 3530 HGC 4030 HGC 5030	HGW 3513 HGW 4013 HGW 5013 HGW 3521 HGW 4021 HGW 5021
Option Kit B *Choose No.1(PSI) or No.2(FSN)	Straight Drill 1. For PSI Implant(Internal)	Straight Drill 2. For FSN Implant(External)
	SDS 3010A SDS 3310A SDS 3510A SDS 4310A SDS 4810A SDS 3014A SDS 3314A SDS 3514A SDS 4314A SDS 4814A	SDS 3010B SDS 3310B SDS 3510B SDS 4310B SDS 4810B SDS 3015B SDS 3315B SDS 3515B SDS 4315B SDS 4815B
Option Kit C	Option Kit A + Option Kit B	

## SM / SM Int. Surgical Kit

SM Implant System(SM-Submerged)

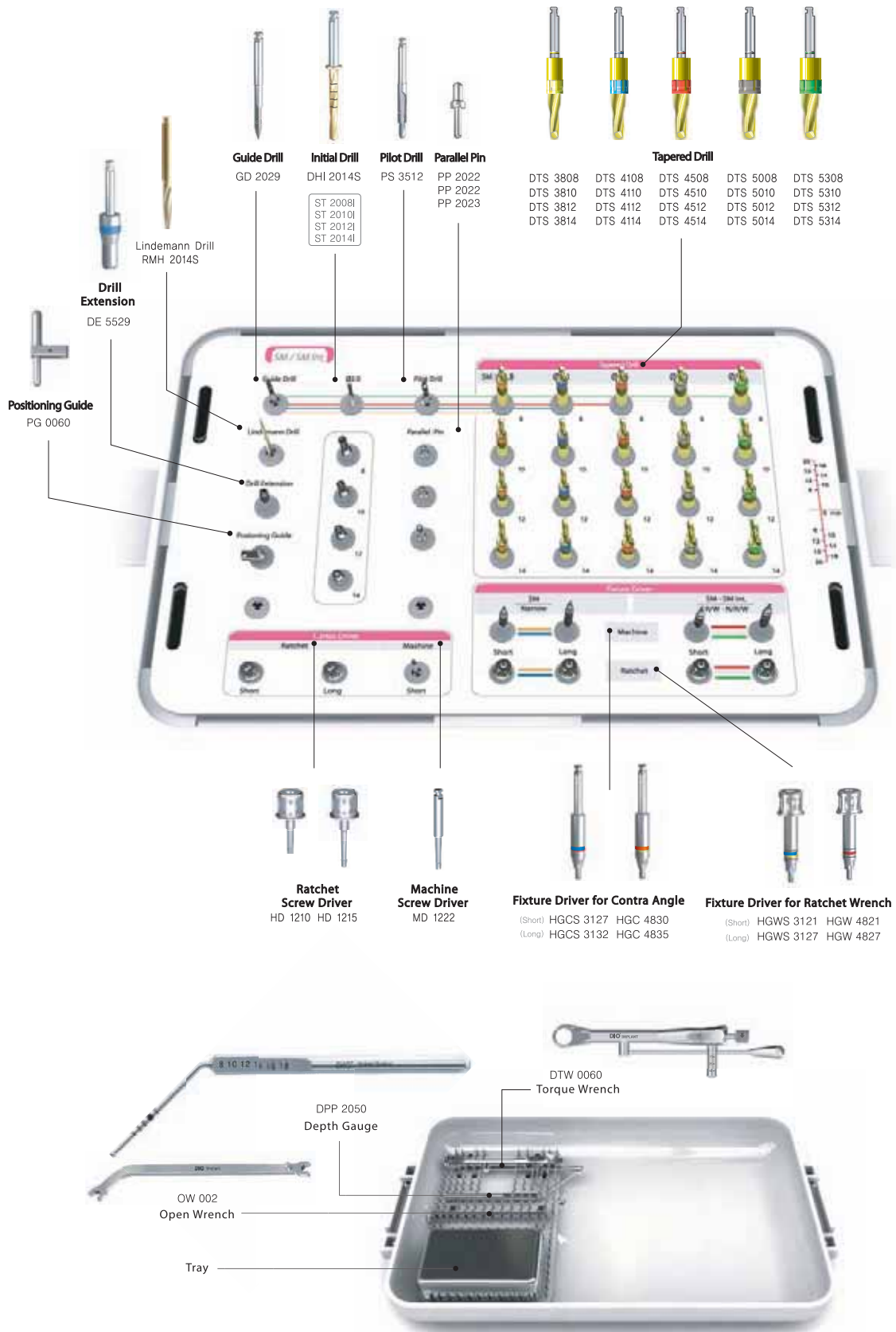

## Surgical Instruments

SM Implant System(SM-Submerged)

### Guide Drill

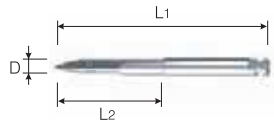

L1/L2	D	
		Ø2.0
25/11		GD 2025
29/15		GD 2029

- Used for drilling initial hole in bone tissue
- Bone density ascertainable during drilling

### Initial Drill

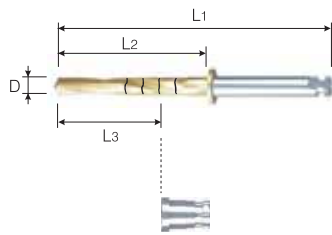

D	Ø2.0
L1	33
L2	18
Code	DHI 2014S
L3	Stopper
8	ST 2008I
10	ST 2010I
12	ST 2012I
14	ST 2014I

### Bone Planer

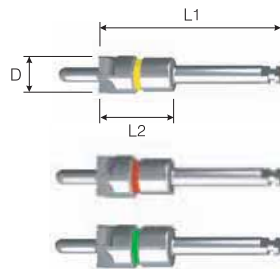

L1/L2	D	Ø4.95	Ø5.65	Ø5.9
24.5/10		BP 5010	BP 5710	BP 5910

- Creates a flat surface on bone
- Extracts desired bone with bone planer after initial drilling
- Handpiece speed: 400-600 rpm

### Drill Extension



L	Code
29.7	DE 5529

- Provides extra length for drills used with handpieces
- Connects to the flat surface of the drill shank

## Surgical Instruments

### SM Implant System(SM-Submerged)

#### Tapered Drill

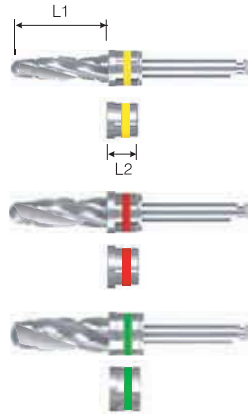

L1 / Fixture Dia.	Ø3.5	Ø4.0	Ø4.8
8	DTI 3508S	DTI 4008S	DTI 4808S
10	DTI 3510S	DTI 4010S	DTI 4810S
12	DTI 3512S	DTI 4012S	DTI 4812S
14	DTI 3514S	DTI 4014S	DTI 4814S

L2	Stopper		
4	ST 3500I	ST 4000I	ST 4800I
3	ST 3501I	ST 4001I	ST 4801I

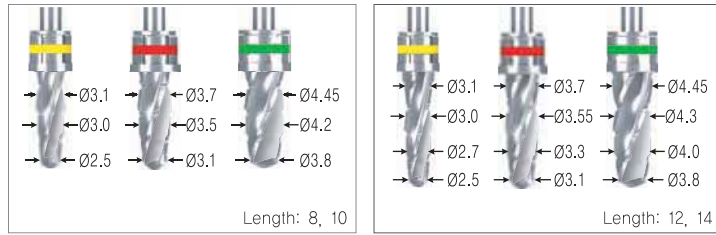

#### Profile Drill

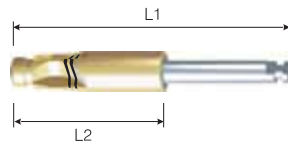

L1/L2 / Fixture Dia.	Ø3.8	Ø4.5	Ø5.3
26.3/12.3	PFD 3805S	PFD 4505S	PFD 5305S
31.3/17.3	PFD 3810S	PFD 4510S	PFD 5310S
36.3/22.3	PFD 3815S	PFD 4515S	PFD 5315S

#### SM Tapered Drill

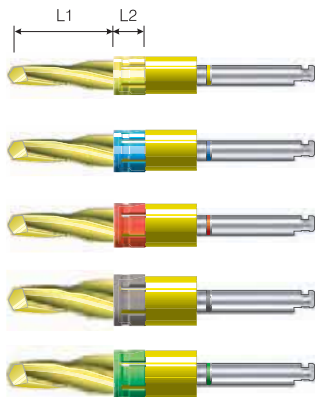

L1 / Fixture Dia.	Ø3.8	Ø4.1	Ø4.5	Ø5.0	Ø5.3
8	DTS 3808	DTS 4108	DTS 4508	DTS 5008	DTS 5308
10	DTS 3810	DTS 4110	DTS 4510	DTS 5010	DTS 5310
12	DTS 3812	DTS 4112	DTS 4512	DTS 5012	DTS 5312
14	DTS 3814	DTS 4114	DTS 4514	DTS 5014	DTS 5314

L2	Stopper				
4	ST 3804	ST 4104	ST 4504	ST 5004	ST 5304
3	ST 3803	ST 4103	ST 4503	ST 5003	ST 5303

-SM Tapered Drill(Tapered+Profile drill)



## Surgical Instruments

SM Implant System(SM-Submerged)

Lindemann Drill

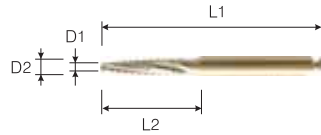

L1/L2	D1/D2	
		Ø1.4/Ø2.0
30/14		RMH 2014S

- Provides drill direction adjustment
- Useful in site preparation and ridge reduction in extractions

Pilot Drill

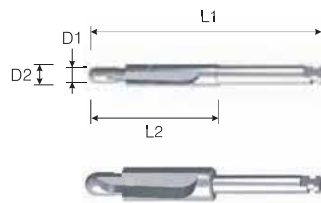

L1/L2	D1/D2	
		Ø2.0/Ø2.7
31/17		PS 3512

L1/L2	D1/D2	
		Ø3.0/Ø4.3
31/17		PS 4812

- Creates a path for drilling hole
- Creates accurate guide holes for the next step in surgical extraction

Tap Drill

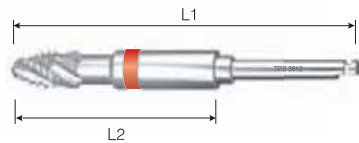

L1/L2	Fixture Dia.	Ø3.8	Ø4.1	Ø4.5	Ø5.0	Ø5.3
36.2/20.2		TPS 3812	TPS 4112	TPS 4512	TPS 5012	TPS 5312
41.2/25.2		TPS 3817	TPS 4117	TPS 4517	TPS 5017	TPS 5317

Tap Adapter



L		
5		TAPA 3011
9.5		TAPA 3016

Positioning Guide

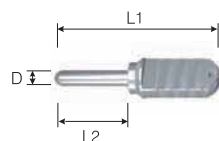

L1/L2	D	
		Ø2.0
22/10		PG 0050

- Marks space between fixtures
- Used after initial drilling

## Surgical Instruments

SM Implant System(SM-Submerged)

Parallel Pin

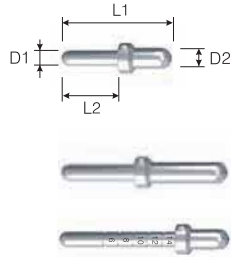

L1/L2 \ D1/D2	
	Ø2.0/Ø2.7
15/8	PP 2015
22/10	PP 2022
23/16	PP 2023

- Provides location and direction of site preparation
- Drill site depth survey
- Package Contents: Available as a part of a set or individual packaging

Depth Gauge



D	Ø2.0
Code	DPP 2050

Torque Wrench



Code	DTW 0060
------	----------

- Used in fixture implantation or screw repair
- Torque values (0, 15, 35, 50 Ncm) laser etched into the handle
- Convenient disassembly for easy cleaning

Open Wrench



Code	OW 002
------	--------

- Used in removing mounts from weak bone tissue
- 30° neck angle for maximum comfort and ease of use

Tissue Punch

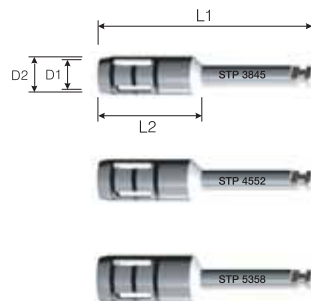

L1/L2 \ D1/D2	
	Ø3.8(Inner)/Ø4.5(Outer)
27/13	STP 3845

L1/L2 \ D1/D2	
	Ø4.5(Inner)/Ø5.2(Outer)
27/13	STP 4552

L1/L2 \ D1/D2	
	Ø5.3(Inner)/Ø5.8(Outer)
27/13	STP 5358

## Surgical Instruments

SM Implant System(SM-Submerged)

### Machine Screw Driver

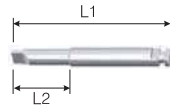

Type	L1/L2	Code
0.5 Slot	22/8	MD 0522
	30/16	MD 0530
0.9 Hex	22/8	MD 0922
	30/16	MD 0930
1.2 Hex	22/8	MD 1222
	30/16	MD 1230
1.7 Torx	22/8	MD 1722
	30/16	MD 1730

### Ratchet Screw Driver



Type	L	Code
0.5 Slot	10	HD 0510
	15	HD 0515
0.9 Hex	10	HD 0910
	15	HD 0915
	20	HD 0920
1.2 Hex	5	HD 1205
	10	HD 1210
	15	HD 1215
	20	HD 1220
1.7 Torx	10	HD 1710
	15	HD 1715
	20	HD 1720

### Ball Abutment Driver



L	Code
6	HD 2406
12	HD 2412

### Fixture Driver for Contra Angle

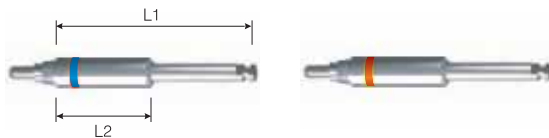

L1/L2	D	Ø3.8	Ø4.5 / Ø5.3
21/6.9		HGCS 3121	HGC 4824
27/12.9		HGCS 3127	HGC 4830
32/17.9		HGCS 3132	HGC 4835

### Fixture Driver for Ratchet Wrench



L	D	Ø3.8	Ø4.5 / Ø5.3
6		HGWS 3113	HGW 4813
14		HGWS 3121	HGW 4821
20		HGWS 3127	HGW 4827

## Surgical Instruments

SM Implant System(SM-Submerged)

Fixture Mount Driver



L \ Type	M1.8	M2.0
18	HMDI 1818	HMDI 2018
23	HMDI 1823	HMDI 2023

Abutment Removing Driver

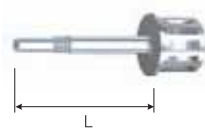

L \ Type	M1.8	M2.0
15	HARD 1815	HARD 2015
20	HARD 1820	HARD 2020

Solid Abutment Driver



L \ D	Ø3.9	Ø4.8	Ø5.8
6	HDS 3906	HDS 4806	HDS 5806
12	HDS 3912	HDS 4812	HDS 5812

Reamer Set



Reamer Cutter



Code	SRC 39	SRC 48	SRC 58

Reamer Pin



D	Ø3.5	Ø4	Ø5
Code	SRP 39	SRP 48	SRP 58

Trepine Drill

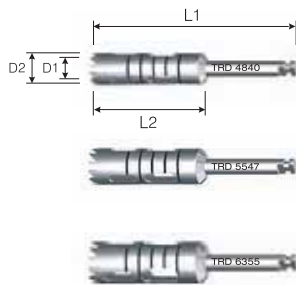

L1/L2 \ D1/D2	Ø4.0(Inner)/Ø4.8(Outer)
32/18	TRD 4840

L1/L2 \ D1/D2	Ø4.7(Inner)/Ø5.5(Outer)
32/18	TRD 5547

L1/L2 \ D1/D2	Ø5.5(Inner)/Ø6.3(Outer)
32/18	TRD 6355

Ratchet Wrench



Code	DRW 050

## Fixture Driver

Instructions for proper fixture driver use  
Remove driver from fixture only after adhesion

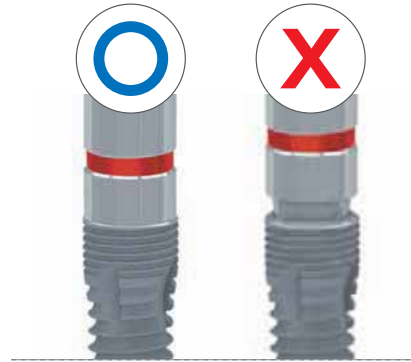

## Site Preparation

SM-Submerged Fixture / Ø4.5mm(Length: 10mm)

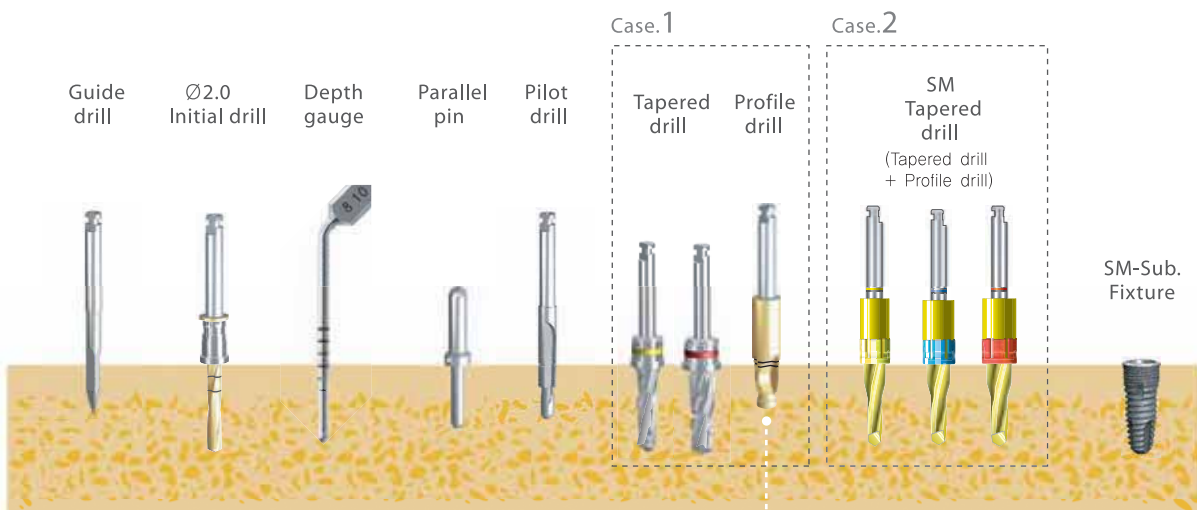

### Profile drill

Used to shape top of fixture (Straight & Taper shape)

Insertion depth: Drilling depth is determined by bone tissue  
Drills up to B depth in case of D1/D2 bone.  
Tap drill is recommended in cases where the D1 bone tissue is resistant.  
Drills up to A depth in case of D2/D3 bone.  
Profile drill is not recommended in cases where the D4 bone tissue is weak.

This drill is designed to prevent excess torque.  
Implant depth is adjustable.

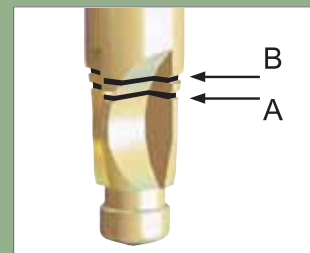

## SM Extra-Wide Surgical Kit

SM Implant System(Extra-Wide)

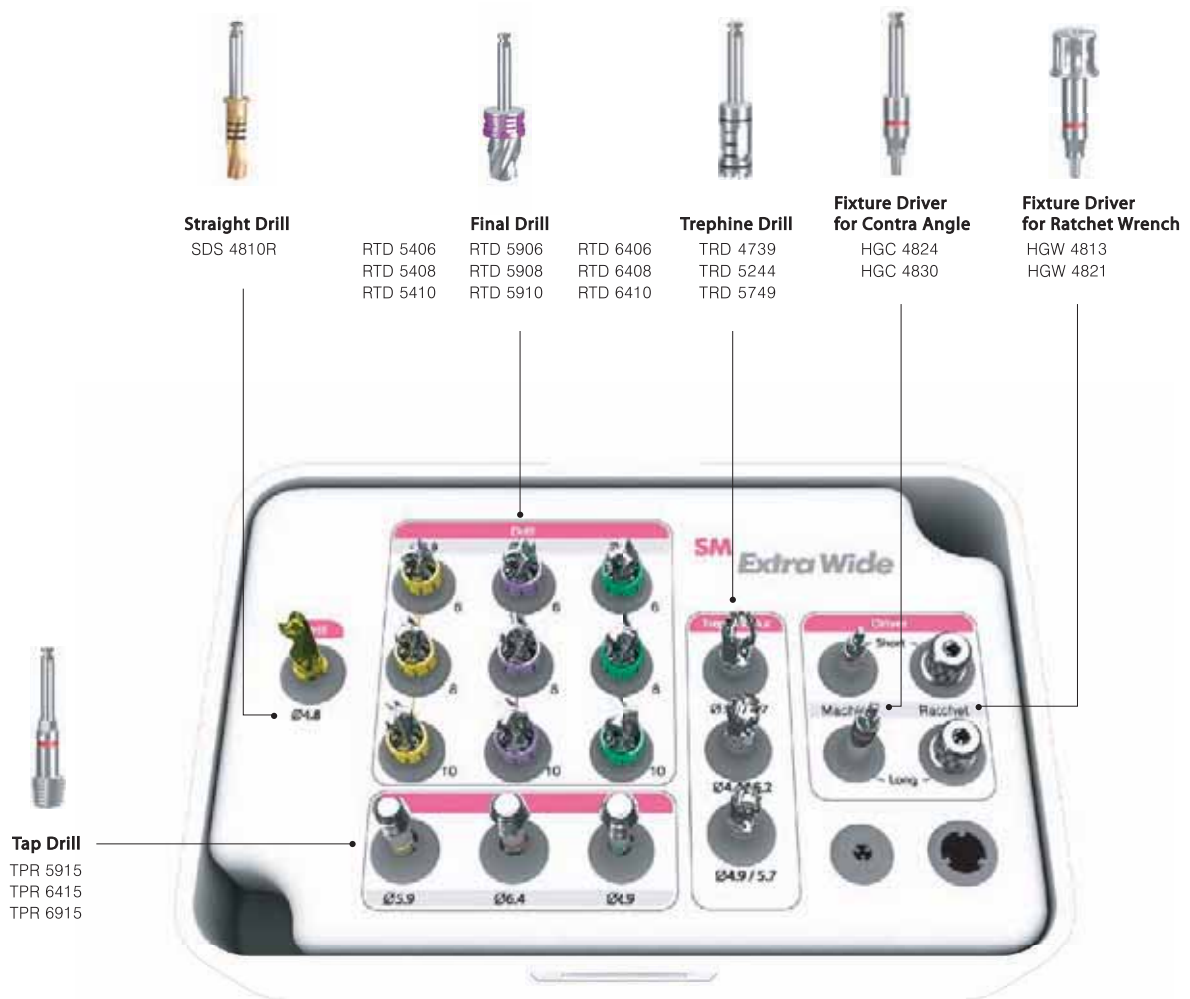

## SM Extra-Wide Surgical Kit

SM Implant System(Extra-Wide)

Straight Drill

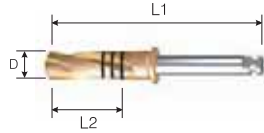

L1/L2	D	Ø4.8
29/10		SDS 4810R

Trephine Drill

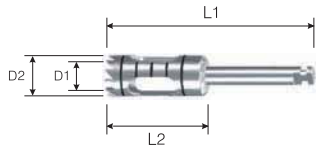

L1/L2	D1/D2	Inner Diameter/Outer Diameter		
27/13		Ø3.9/Ø4.7	Ø4.4/Ø5.2	Ø4.9/Ø5.7
		TRD 4739	TRD 5244	TRD 5749

Final Drill

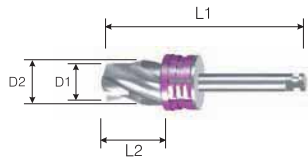

L1/L2	D1/D2	Ø4.5/Ø5.4	Ø5/Ø5.9	Ø5.5/Ø6.4
25/6		RTD 5406	RTD 5906	RTD 6406
27/8		RTD 5408	RTD 5908	RTD 6408
29/10		RTD 5410	RTD 5910	RTD 6410

Tap Drill

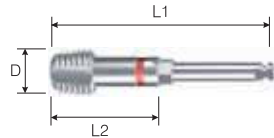

L1/L2	D	5.9	6.4	6.9
31.1/15		TPR 5915	TPR 6415	TPR 6915

Fixture Driver for Ratchet Wrench

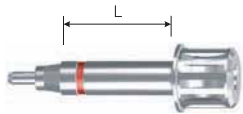

L	6	HGW 4813
	14	HGW 4821
	20	HGW 4827

Fixture Driver for Contra Angle

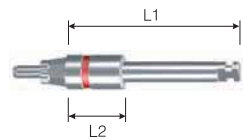

L1/L2	21/6.9	HGC 4824
	27/12.9	HGC 4830
	32/17.9	HGC 4835

## Site Preparation

SM-Extra-Wide Fixture / Ø6.4mm(Length: 8mm)

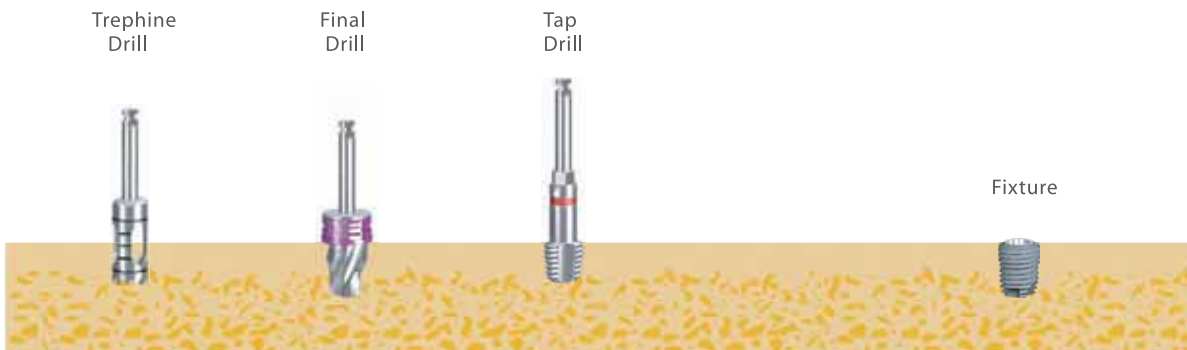





# Int.

## Internal Implant System

SM-Internal / IFI / PSI



System Flowchart .....	052
Implants/Healing Abutments .....	057
(SM-Internal, IFI, PSI)	
Restorative Products .....	065
Surgical Kit	
Master Surgical Kit .....	076
SM / SM Int.Surgical Kit .....	077
Site Preparation (SM-Internal) .....	083
IFI/SM Surgical Kit .....	084
PSI Surgical Kit .....	085
Site Preparation (IFI) .....	091
Site Preparation (PSI) .....	091

**DIO IMPLANT SYSTEM**

[www.dio.co.kr](http://www.dio.co.kr)

Internal System Flowchart  
Cement-Retained Restorations - Solid Abutment

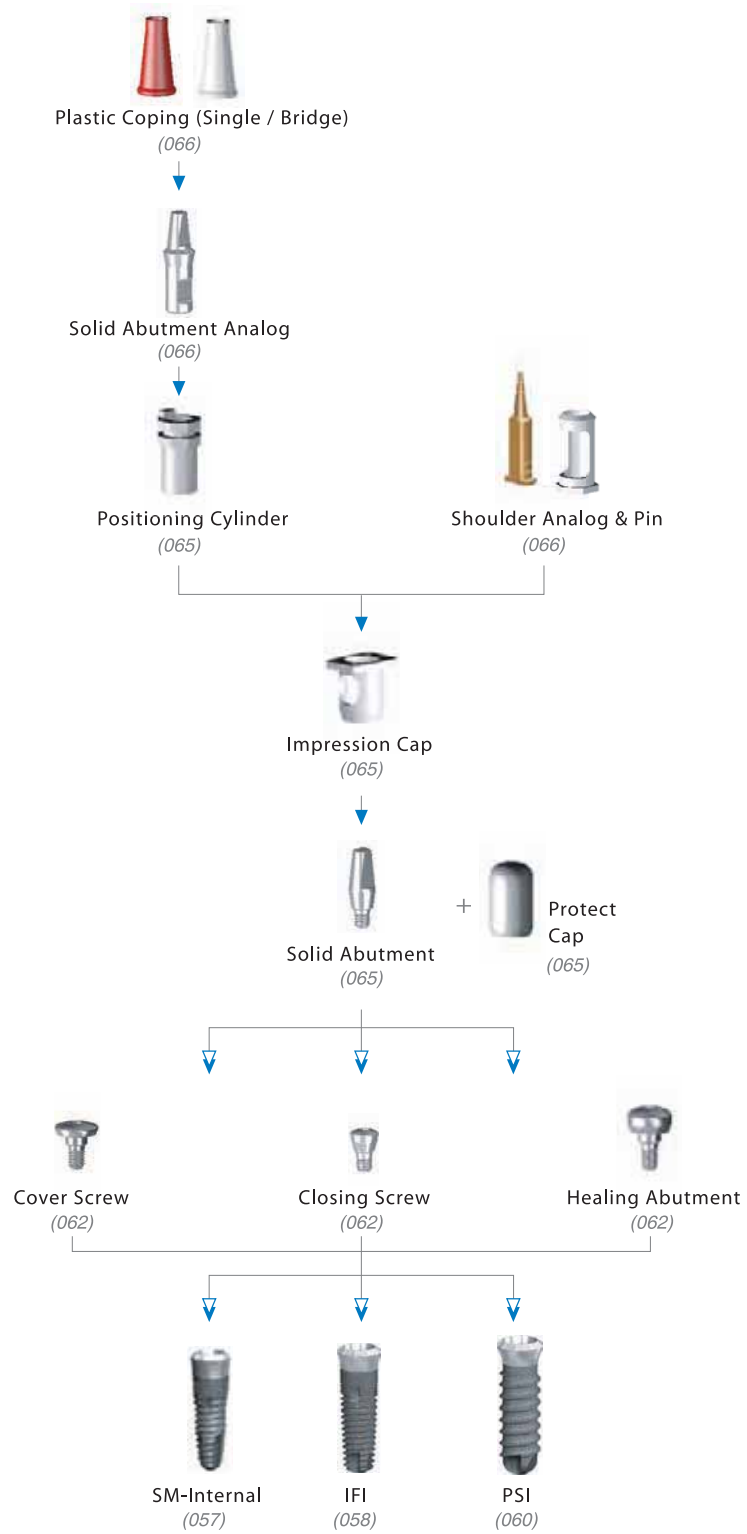

Internal System Flowchart

Cement-Retained Restorations - Excellent Solid Abutment

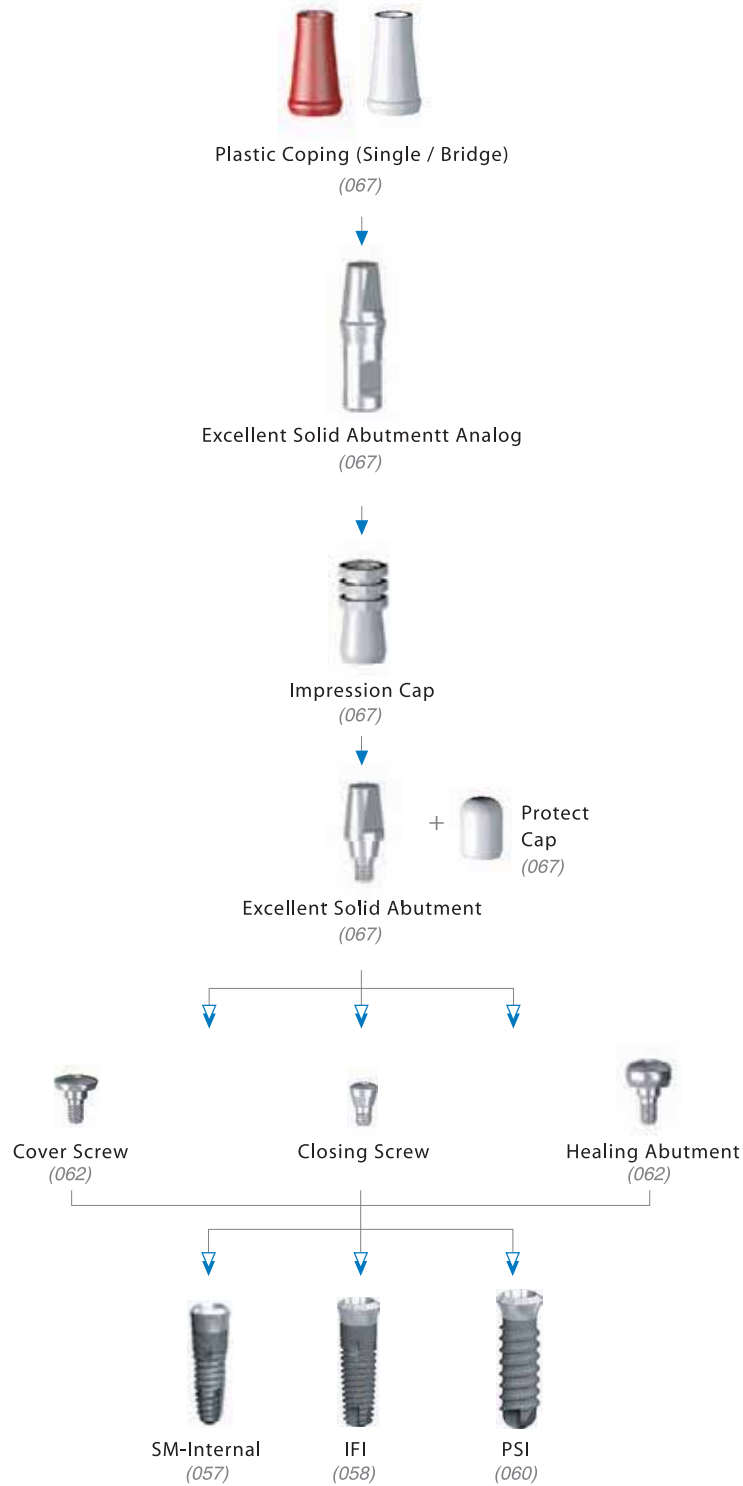

Internal System Flowchart  
 Screw-Retained Restorations - Octa Abutment

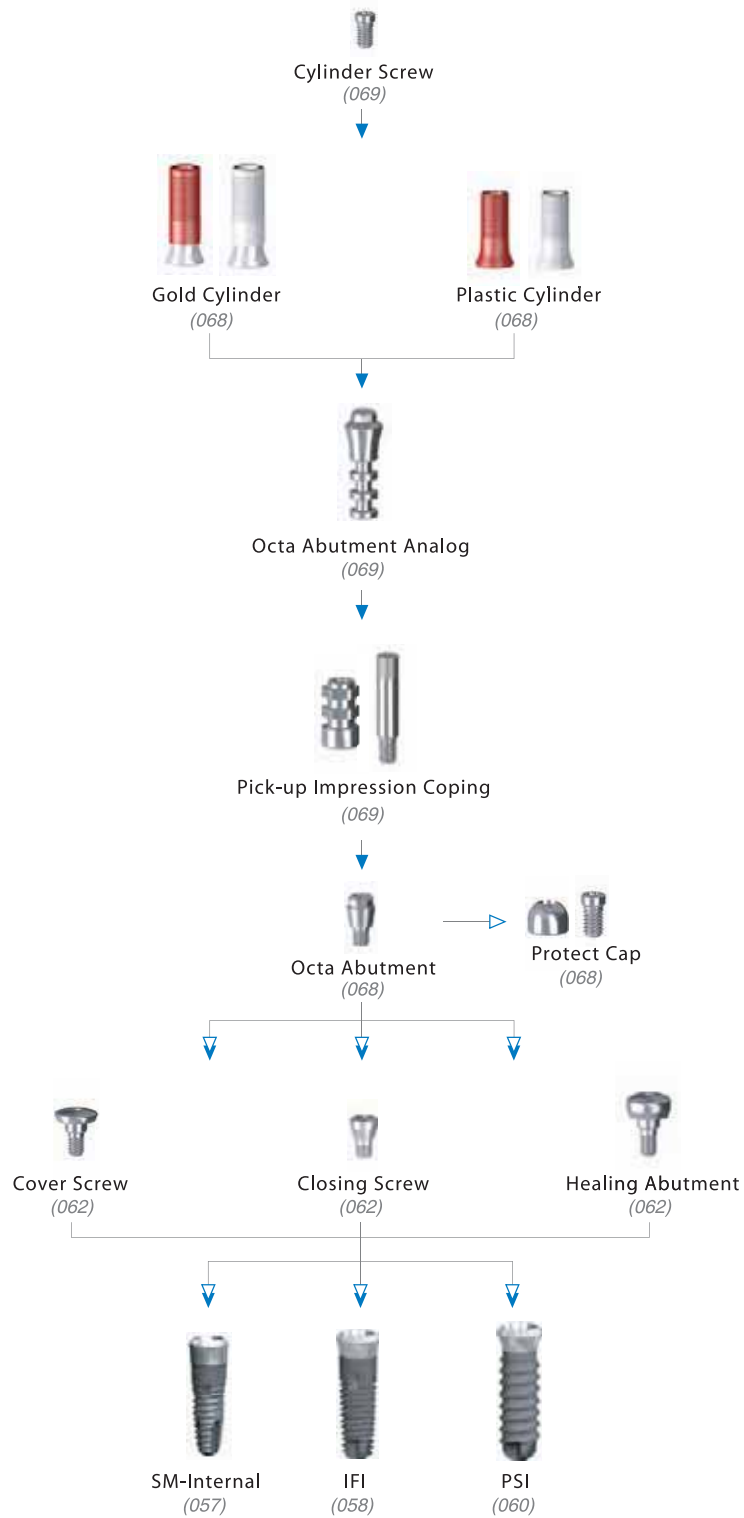

Internal System Flowchart

Cement-Retained Restorations - Cemented Abutment  
Cement-Retained Restorations - Extension Cemented Abutment  
Cement-Retained Restorations - Angled Abutment

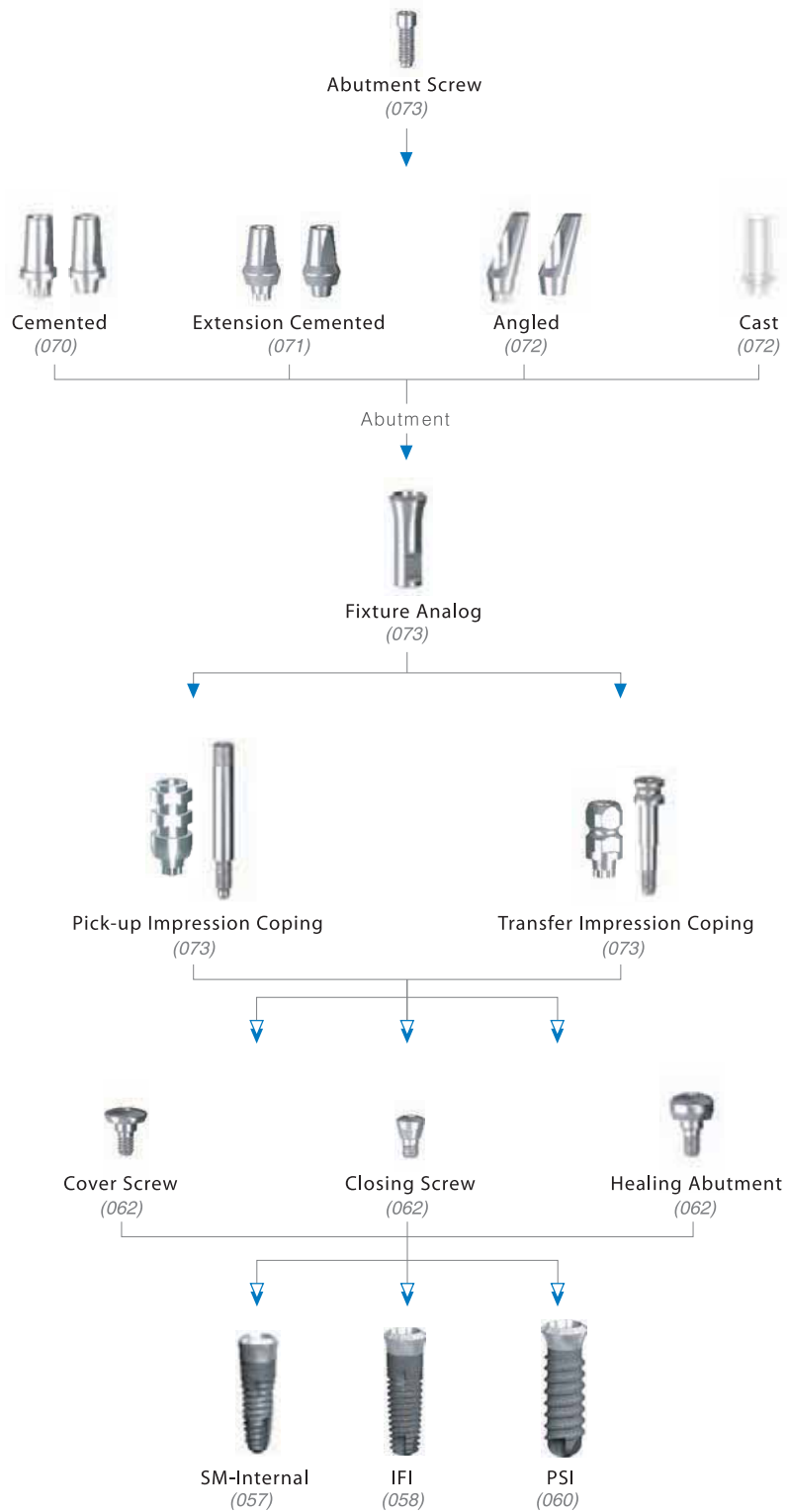

Internal System Flowchart

Overdenture-Retained Restorations - Ball Abutment

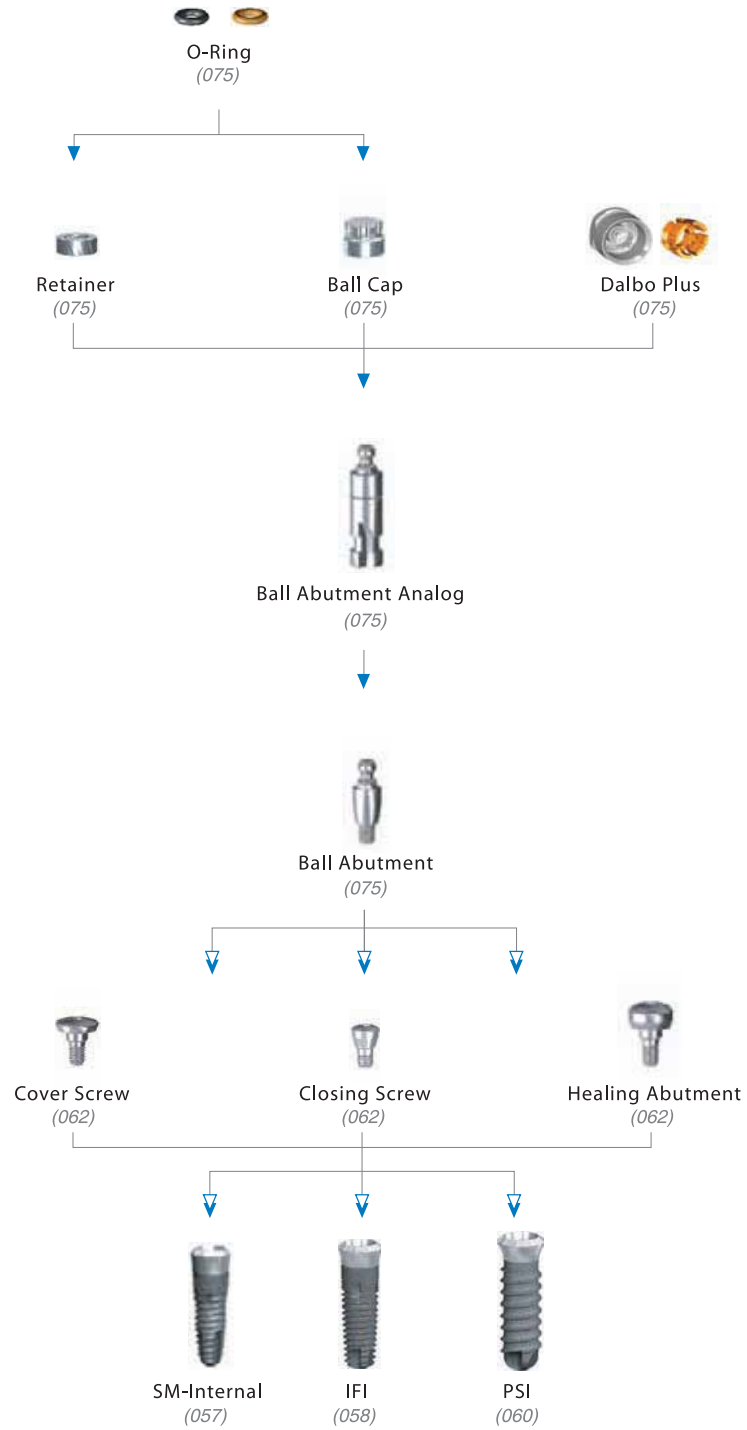

› Internal Torx Connection

Superior to Hex internal connection  
More fixture and driver contact  
No distortion with high torque

› Morse Taper

Convenient abutment insertion  
Wide abutment contact area  
High resistance to unscrewing

› Double Thread

Secure initial seating prevents cortical bone loss

› Root Form Design

Root form design enables excellent stability  
Reduces possibility of touching adjacent teeth root during implant insertion

› Self Tapping

Advanced thread and apex design enable easy self tapping and excellent initial stability in extraction sockets

› Surface

Biocompatible RBM

Narrow Platform Ø4.8



D	D1:Ø3.8 D2:Ø3.3
L \ C	2
8	SIFN 3808
10	SIFN 3810
12	SIFN 3812
14	SIFN 3814

\*Abutment and components are compatible with Regular size implant

Regular Platform Ø4.8

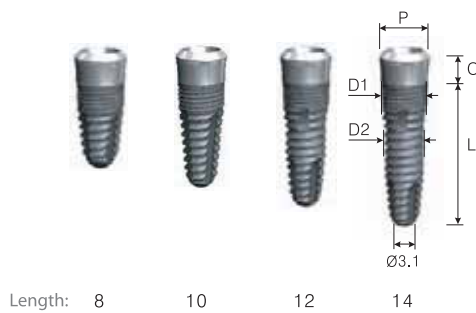

D	D1:Ø4.5 D2:Ø4.0
L \ C	2
8	SIFR 4508
10	SIFR 4510
12	SIFR 4512
14	SIFR 4514

Wide neck Platform Ø6.5



D	D1:Ø5.3 D2:Ø4.8
L \ C	2
8	SIFW 5308N
10	SIFW 5310N
12	SIFW 5312N
14	SIFW 5314N

## Internal IFI Fixture



### Internal Torx Connection

Superior to Hex internal connection  
More fixture and driver contact  
No distortion with high torque

### Morse Taper

Convenient abutment insertion  
Wide abutment contact area  
High resistance to unscrewing

### Double Thread

Secure initial seating prevents cortical bone loss

### Root Form Design

Root form design enables excellent stability  
Reduces possibility of touching adjacent teeth root during implant insertion

### Self Tapping

Advanced thread and apex design enable easy self tapping and excellent initial stability in extraction sockets

### Surface

Biocompatible RBM

### Narrow Platform Ø4.8



D	Ø3.5
L \ C	1.8
8	IFI 3508PM
10	IFI 3510PM
12	IFI 3512PM
14	IFI 3514PM

### Regular Platform Ø4.8

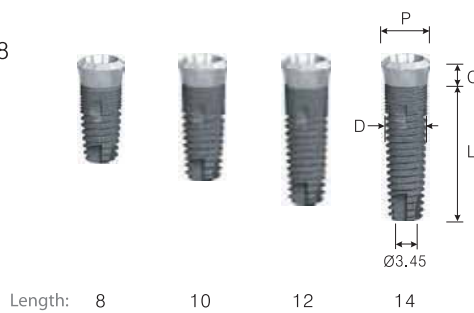

D	Ø4.1
L \ C	1.8
8	IFI 4008PM
10	IFI 4010PM
12	IFI 4012PM
14	IFI 4014PM



D	Ø4.1
L \ C	2.8
8	IFI 4008M
10	IFI 4010M
12	IFI 4012M
14	IFI 4014M



# Internal IFI Fixture



## Wide

Platform  $\text{Ø}4.8$

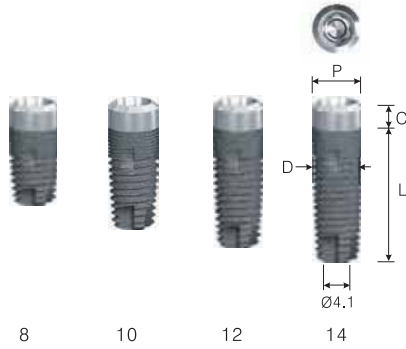

Length: 8      10      12      14

D	$\text{Ø}4.8$
L \ C	1.8
8	IFI 4808PM
10	IFI 4810PM
12	IFI 4812PM
14	IFI 4814PM



Length: 8      10      12      14

D	$\text{Ø}4.8$
L \ C	2.8
8	IFI 4808M
10	IFI 4810M
12	IFI 4812M
14	IFI 4814M



Length: 8      10      12      14

D	$\text{Ø}5.5$
L \ C	2
8	IFI 5508PM
10	IFI 5510PM
12	IFI 5512PM
14	IFI 5514PM

## Wide Neck

Platform  $\text{Ø}6.5$



Length: 8      10      12      14

D	$\text{Ø}4.8$
L \ C	2
8	IFI 6508PM
10	IFI 6510PM
12	IFI 6512PM
14	IFI 6514PM



Length: 8      10      12      14

D	$\text{Ø}5.5$
L \ C	2
8	IFI 6508PMR
10	IFI 6510PMR
12	IFI 6512PMR
14	IFI 6514PMR

Internal System

## Internal PSI Fixture



### Internal Torx Connection

- Superior to Hex internal connection
- More fixture and driver contact
- No distortion with high torque

### Surface

Biocompatible RBM

### Morse Taper

- Convenient abutment insertion
- Wide abutment contact area
- High resistance to unscrewing

### Narrow

Platform  $\varnothing 4.8$



Length: 8 10 12 14

D	$\varnothing 3.5$
L \ C	1.8
8	PSI 3508P
10	PSI 3510P
12	PSI 3512P
14	PSI 3514P

### Regular

Platform  $\varnothing 4.8$

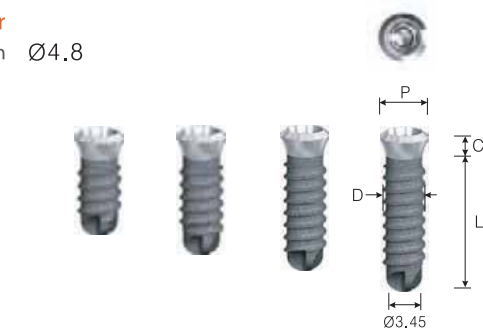

Length: 8 10 12 14

D	$\varnothing 4.1$
L \ C	1.8
8	PSI 4008P
10	PSI 4010P
12	PSI 4012P
14	PSI 4014P



Length: 8 10 12 14

D	$\varnothing 4.1$
L \ C	2.8
8	PSI 4008
10	PSI 4010
12	PSI 4012
14	PSI 4014

Wide

Platform Ø4.8



Length: 8 10 12 14

D	Ø4.8
L \ C	1.8
8	PSI 4808P
10	PSI 4810P
12	PSI 4812P
14	PSI 4814P

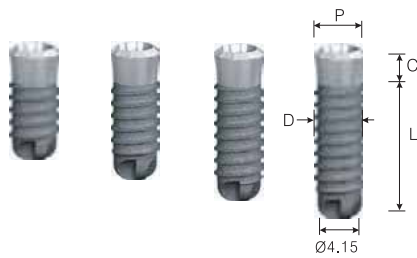

Length: 8 10 12 14

D	Ø4.8
L \ C	2.8
8	PSI 4808
10	PSI 4810
12	PSI 4812
14	PSI 4814

Wide Neck

Platform Ø6.5



Length: 8 10 12 14

D	Ø4.8
L \ C	2
8	PSI 6508P
10	PSI 6510P
12	PSI 6512P
14	PSI 6514P

Cover Screw



P \ D	Ø5.5	Ø5.5	Ø5.5	Ø7.0
Ø4.8	AHI 48602H			-
Ø6.5	-			AHI 65702H

- Uses 1,2 hex driver
- Package Contents: Cover Screw
- Tightening Torque: 5-8 Ncm

Closing Screw



D	Code
Ø3.5	CHI 4800NH

- Used in instances of restrictive and/or insufficient spaces
- Uses 1,2 hex driver
- Package Contents: Closing Screw
- Tightening Torque: 5-8 Ncm

Healing Abutment



P	L \ D	Ø5.5	Ø5.5	Ø5.5	Ø7.0
Ø4.8	2	AHI 48602H			-
	3	AHI 48603H			-
	4	AHI 48604H			-
Ø6.5	2	-			AHI 65702H
	3	-			AHI 65703H
	4	-			AHI 65704H

- Uses 1,2 hex driver
- Package Contents: Healing Abutment
- Tightening Torque: 5-8 Ncm

# Abutments for Internal Implant System

---



**Octa**  
(068)



**Cylinder**  
(068)



**Cast**  
(072)



**Fixture**



**Solid**  
(065)



**Ball**  
(075)



**Excellent Solid**  
(067)



**Angled**  
(072)



**Cemented**  
(070)



**Extension  
Cemented**  
(071)

# Abutment Selection Guide

Internal System

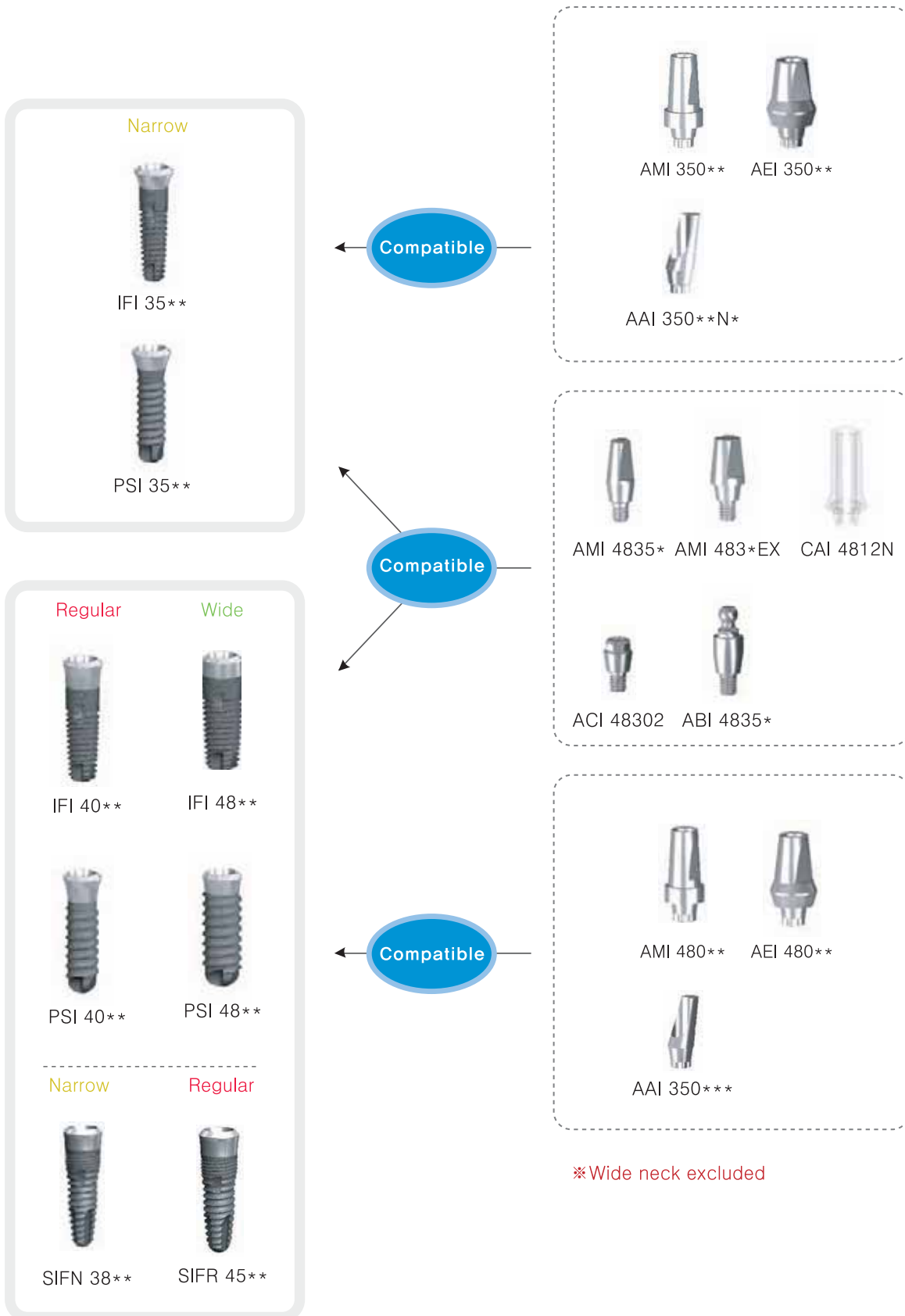

**Solid Abutment**



Fixture Platform	Ø4.8			Ø6.5
L \ D	Ø3.5	Ø3.5	Ø3.5	Ø4.3
4	AMI 48354			AMI 65434
5.5	AMI 48355			AMI 65435
7	AMI 48357			-

- Used for standard cement type prosthetic fabrication
- Single body abutment and screw construction
- Secure 8° Morse tapered connection construction
- Prosthetic rotation prevention
- Uses Ø3,5 solid abutment driver
- Uses Ø4,3 solid abutment driver
- Package Contents: Abutment + Protect Cap
- Tightening Torque: 35 Ncm

**Protect Cap**

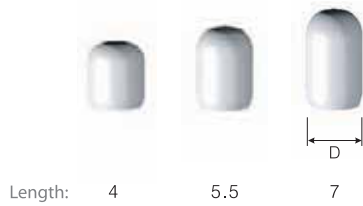

Fixture Platform	Ø4.8			Ø6.5
L \ D	Ø5.5	Ø5.5	Ø5.5	Ø7.5
4	HMI 48554			HMI 65704
5.5	HMI 48555			HMI 65705
7	HMI 48557			-

- Protects the abutment and keeps foreign particles to a minimum
- Keeps the place of future prosthetic
- Convenient locking mechanism

**Impression Cap**



Fixture Platform	Ø4.8			Ø6.5
L \ D	Ø5.7	Ø5.7	Ø5.7	Ø7.2
8	IPI 48001			IPI 65001

- Used for making impression with solid abutments
- Used in conjunction with solid positioning cylinder
- Convenient locking mechanism
- Package Contents: Impression Cap

**Positioning Cylinder**



Fixture Platform	Ø4.8			Ø6.5
L \ D	Ø4.5	Ø4.5	Ø4.5	Ø6.0
4	IPI 48002Y			IPI 65002Y
5.5	IPI 48002G			IPI 65002G
7	IPI 48002B			-

- Used for making impression with solid abutments
- Used in conjunction with solid impression cap
- Simple color coding according to abutment diameter  
 Length(4,0: Yellow, 5,5: Grey, 7,0: Blue)
- Package Contents: Positioning Cylinder

**Solid Abutment Analog**



Fixture Platform	Ø4.8			Ø6.5
L \ D	Ø4.8	Ø4.8	Ø4.8	Ø6.5
4	RMI 48004N			RMI 65004N
5.5	RMI 48005N			RMI65005N
7	RMI 48007N			-

-Provides anchor point for fabricating implant prosthetics on working model.  
 -Package Contents: Analog

**Plastic Coping**



Fixture Platform	Ø4.8			Ø6.5
L \ Type \ D	Ø5.0	Ø5.0	Ø5.0	Ø6.7
10	Single	IPI 48004		IPI 65004
	Bridge	IPI 48004N		IPI 65004N

-Provides a framework for prosthetic for use with Solid Lab Analog  
 -Simple color coding according to type of prosthetic  
 Single: Red Bridge: White  
 -Determine margin using Reamer after casting prosthetic  
 -Package Contents: Plastic Coping

**Shoulder Analog & Pin**



Fixture Platform	Ø4.8		
L \ D	Ø4.8	Ø4.8	Ø4.8
5.5	RMI 48001		

-Provides impression for model work in event of missing solid abutment  
 -Provides a platform for fixture fabrication  
 -Used in solid shoulder analog construction  
 -Package Contents: Shoulder Analog + Pin



Excellent Solid Abutment



L	Fixture Platform	Ø4.8	Ø4.8	Ø4.8
4			AMI 48434EX	
5.5			AMI 48435EX	
7			AMI 48437EX	

Protect Cap



L	Fixture Platform	Ø4.8	Ø4.8	Ø4.8
4			HMI 48554EX	
5.5			HMI 48555EX	
7			HMI 48557EX	

Impression Cap



L	Fixture Platform	Ø4.8	Ø4.8	Ø4.8
12			IPI 48002YEX	
			IPI 48002GEX	
			IPI 48002BEX	

Excellent Solid Abutment Analog



L	Fixture Platform	Ø4.8	Ø4.8	Ø4.8
4			RMI 48004EX	
5.5			RMI 48005EX	
7			RMI 48007EX	

Plastic Coping



L	Fixture Platform	Ø4.8	Ø4.8	Ø4.8
12			IPI 48004EX	
			IPI 48004NEX	

Internal System

**Octa Abutment**



Fixture Platform	Ø4.8			Ø6.5
L \ D	Ø3.5	Ø3.5	Ø3.5	Ø4.3
5.5	ACI 48302			-
7	-			ACI 65302

- Used in case of crossed path or screw corrosion prevention
- Uses Octa Abutment Driver
- Package Contents: Octa Abutment
- Tightening Torque: 35 Ncm

**Protect Cap**

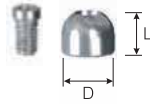

Fixture Platform	Ø4.8			Ø6.5
L \ D	Ø5.0	Ø5.0	Ø5.0	Ø7.0
4	HCI 48504			HCI 65704

- Protects the Octa abutment and keeps foreign particles to a minimum
- Uses 1,7 Torx Driver
- Package Contents: Protect Cap + Cylinder Screw
- Tightening Torque: 20 Ncm

**Gold Cylinder**

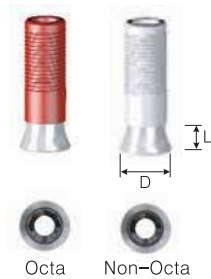

Fixture Platform	Ø4.8		
L \ Type \ D	Ø5.5	Ø5.5	Ø5.5
4	Octa	AGI 48504	
	Non-Octa	AGI 48504N	

- Enables custom fabrication using the best quality dental gold alloy
- Cylinder Melting Point: 1400°C–1500°C (depending on casting machine)
- Uses 1,7 Torx Driver
- Package Contents: Gold Cylinder + Cylinder Screw
- Tightening Torque: 20 Ncm

**Plastic Cylinder**

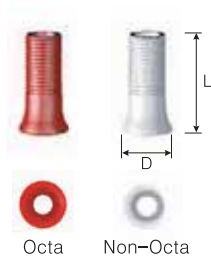

Fixture Platform	Ø4.8			Ø6.5
L \ Type \ D	Ø5.0	Ø5.0	Ø5.0	Ø7.0
10	Octa	API 48514	API 65714	
	Non-Octa	API 48514N	API 65714N	

- Enables custom fabrication using dental gold alloy
- Less precise than the gold cylinder
- Uses 1,7 Torx Driver
- Package Contents: Plastic Cylinder + Cylinder Screw
- Tightening Torque: 20 Ncm

Pick-up Impression Coping



Fixture Platform		Ø4.8			Ø6.5
L	Type	Ø5.5	Ø5.5	Ø5.5	Ø7.5
	D				
10	Octa	IPI48610			IPI 65710
	Non-Octa	IPI48610N			IPI 65710N

- Used for pick-up impressions with custom trays
- Minimizes distortion
- Uses 1,2 Hex Driver
- Package Contents: Impression Coping + Guide Pin

Internal System

Octa Abutment Analog



Fixture Platform		Ø4.8			Ø6.5
L	D	Ø5.0	Ø5.0	Ø5.0	Ø6.5
14		RCI 48014			RCI 65014

- Provides anchor point for fabricating Octa Abutment configuration
- Package Contents: Octa Abutment Analog

Cylinder Screw



Code	
	STI 2004

### Cemented Abutment

- Used in cases of abutment path adjustment and where customization is needed
- Used for standard cement type prosthetic fabrication
- Secure 8° Morse tapered connection construction
- Prosthetic rotation prevention
- Uses 1,7 Torx Driver
- Package Contents: Abutment + Abutment Screw
- Tightening Torque: 35 Ncm



#### Narrow



D	Ø4.3	
C \ Type	Torx	Non-Torx
0	AMI 35007	AMI 48007N

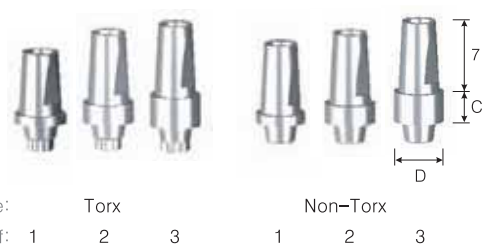

D	Ø4.8	
C \ Type	Torx	Non-Torx
1	AMI 35017	AMI 48017N
2	AMI 35027	AMI 48027N
3	AMI 35037	AMI 48037N

#### Regular / Wide



D	Ø4.3	Ø4.3
C \ Type	Torx	Non-Torx
0	AMI 48007	AMI 48007N

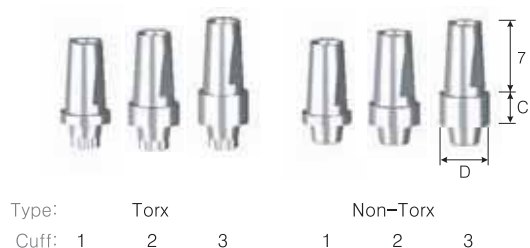

D	Ø4.8	Ø4.8
C \ Type	Torx	Non-Torx
1	AMI 48017	AMI 48017N
2	AMI 48027	AMI 48027N
3	AMI 48037	AMI 48037N

#### Wide Neck



D	Ø6.5	
L \ Type	Torx	Non-Torx
4	AMI 65004	AMI 65004N
5	AMI 65005	AMI 65005N

## Extension Cemented Abutment

- Used in cases of abutment path adjustment and where customization is needed
- Used for standard cement type prosthetic fabrication
- Secure 8° Morse tapered connection construction
- Prosthetic rotation prevention
- Uses 1.7 Torx Driver
- Package Contents: Abutment + Abutment Screw
- Tightening Torque: 35 Ncm



### Narrow



D	Ø5.0	
C \ Type	Torx	Non-Torx
0	AEI 35007	AEI 48007N



D	Ø5.8	
C \ Type	Torx	Non-Torx
1	AEI 35017	AEI 48017N
2	AEI 35027	AEI 48027N
3	AEI 35037	AEI 48037N

### Regular / Wide



D	Ø5.0	Ø5.0
C \ Type	Torx	Non-Torx
0	AEI 48007	AEI 48007N



D	Ø5.8	Ø5.8
C \ Type	Torx	Non-Torx
1	AEI 48017	AEI 48017N
2	AEI 48027	AEI 48027N
3	AEI 48037	AEI 48037N

**Angled Abutment**

- Used in cases where prosthetic path adjustment is necessary
- Secure 8° Morse tapered connection construction
- Uses 1,7 Torx Driver
- Package Contents: Abutment + Abutment Screw
- Tightening Torque: 35 Ncm

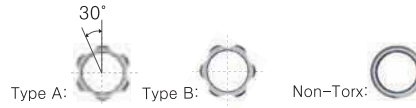

**Narrow**



D	Ø3.5	
Type \ Angled	15°	25°
Torx A	AAI 35015NA	AAI 35025NA
Torx B	AAI 35015NB	AAI 35025NB
Non-Torx	AAI 35015	AAI 35025

**Regular / Wide**



D	Ø3.5	Ø3.5
Type \ Angled	15°	25°
Torx A	AAI 35015A	AAI 35025A
Torx B	AAI 35015B	AAI 35025B
Non-Torx	AAI 35015	AAI 35025

**Wide neck**



D	Ø4.3	
Type \ Angled	15°	20°
Torx A	AAI 43015A	AAI 43020A
Torx B	AAI 43015B	AAI 43020B
Non-Torx	AAI 43015	AAI 43020

**Cast Abutment**

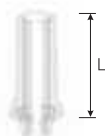

Fixture Platform	Ø4.8
Type \ L	10
Non-Torx	CAI 4812N

Pick-up Impression Coping

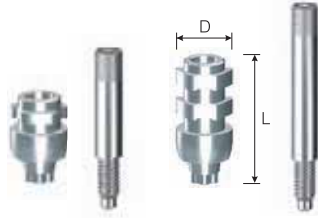

L \ D	Ø5.5	Ø5.5	Ø5.5	Ø6.5
8	IPI 35008	IPI 48008		
12	IPI 35012	IPI 48012	IPI 65012	

- Used for pick-up impressions with custom trays
- Minimizes distortion
- Long and short compositions available
- Used 1,2 Hex Driver
- Package Contents: Impression Coping + Guide Pin

Internal System

Transfer Impression Coping



L \ D	Ø5.0	Ø5.0	Ø5.0
10	ITI 35010	ITI 48010	

- Used for Transfer Type impressions with custom trays
- Popular three sided construction used in impressions
- Torx Type Two-Piece Construction
- Uses 1,2 hex driver
- Package Contents: Impression Coping + Guide Pin (Hex)

Fixture Analog



L \ D	Ø4.8	Ø4.8	Ø4.8	Ø6.5
12	RMI 35012	RMI 48012	RMI 65012	

- Provides anchor point for fixtures
- Package Contents: Analog

Abutment Screw



Code	STN 2008
------	----------

## Ball Abutment

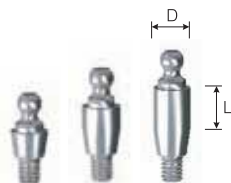

Fixture Platform		Ø4.8		
L \ D		Ø3.5	Ø3.5	Ø3.5
0		ABI 48350		
2		ABI 48352		
4		ABI 48354		

- Used in conjunction with ball type overdenture prosthetic fabrication
- O-Ring Types
  - Black: Laboratory type
  - Orange: Clinical type
- Simple O-Ring retention
- Up to a 20° compensation
- Uses ball abutment driver
- Package Contents: Abutment + O-Ring
- Tightening Torque: 35 Ncm

## Ball Abutment Analog



Fixture Platform		Ø4.8		
L \ D		Ø4.1	Ø4.1	Ø4.1
12		RBN 40412		

- Provides anchor point for ball abutment on working model
- Package Contents: Analog

## Dalbo Plus



	Narrow	Regular	Wide
Code	DBPM 201		

- Titanium housing with 2 stage construction
- Rated for up to 10,000 uses with minimum abrasion to the ball abutment and to the insert
- Simple and convenient retention
- Up to 20° in insertion angle flexibility
- Compatible with all DIO Implant systems

## Retainer

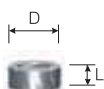

	Narrow	Regular	Wide
L \ D	Ø5.0		
2	RT 0502		

- Package Contents: Retainer + O-Ring

## Ball Cap

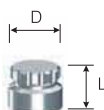

	Narrow	Regular	Wide
L \ D	Ø5.0		
4	BC 5004		

- Superior retention and removability
- Package Contents: Ball Cap + O-Ring

## O-Ring



	Narrow	Regular	Wide
Type \ D	Ø4.5		
Black	OR 0450B		
Orange	OR 0450O		

- Black: Laboratory use for high retention
- Orange: For clinical use (over 6 Ncm)
- Package Contents: O-Ring (1 piece)



Locator



Fixture Platform	Ø4.8					
Cuff	0.73	2	3	4	5	6
Code	LOC 8950	LOC 8951	LOC 8952	LOC 8953	LOC 8954	LOC 8955

- Angled male adjustable even under extreme abutment angle (up to 40°)
- Lowest perpendicular angle
- Simple and precise denture mounting
- Wide variety of males: Great retention

# Master Surgical Kit

## SM Implant System(SM-Internal)

Internal System

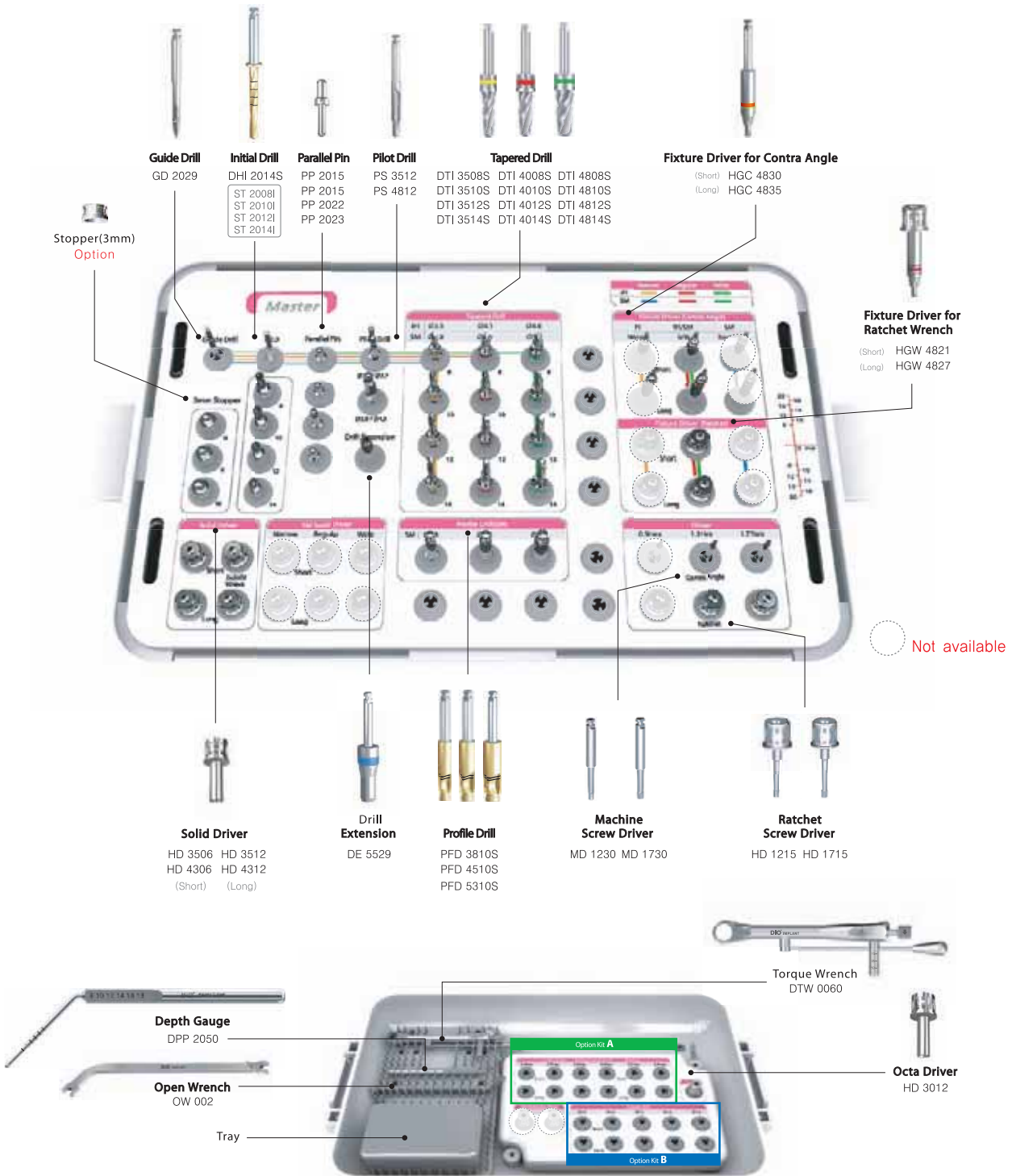

### Master KIT Option

	Fixture Driver for Contra Angle	Fixture Driver for Ratchet Wrench
<b>Option Kit A</b>	HGC 3524 HGC 4024 HGC 5024 HGC 3530 HGC 4030 HGC 5030	HGW 3513 HGW 4013 HGW 5013 HGW 3521 HGW 4021 HGW 5021
<b>Option Kit B</b> *Choose No.1(PSI) or No.2(FSN)	Straight Drill <b>1. For PSI Implant(Internal)</b> SDS 3010A SDS 3310A SDS 3510A SDS 4310A SDS 4810A SDS 3014A SDS 3314A SDS 3514A SDS 4314A SDS 4814A	Straight Drill <b>2. For FSN Implant(External)</b> SDS 3010B SDS 3310B SDS 3510B SDS 4310B SDS 4810B SDS 3015B SDS 3315B SDS 3515B SDS 4315B SDS 4815B
<b>Option Kit C</b>	<b>Option Kit A + Option Kit B</b>	

# SM / SM Int. Surgical Kit

SM Implant System(SM-Internal)

Internal System

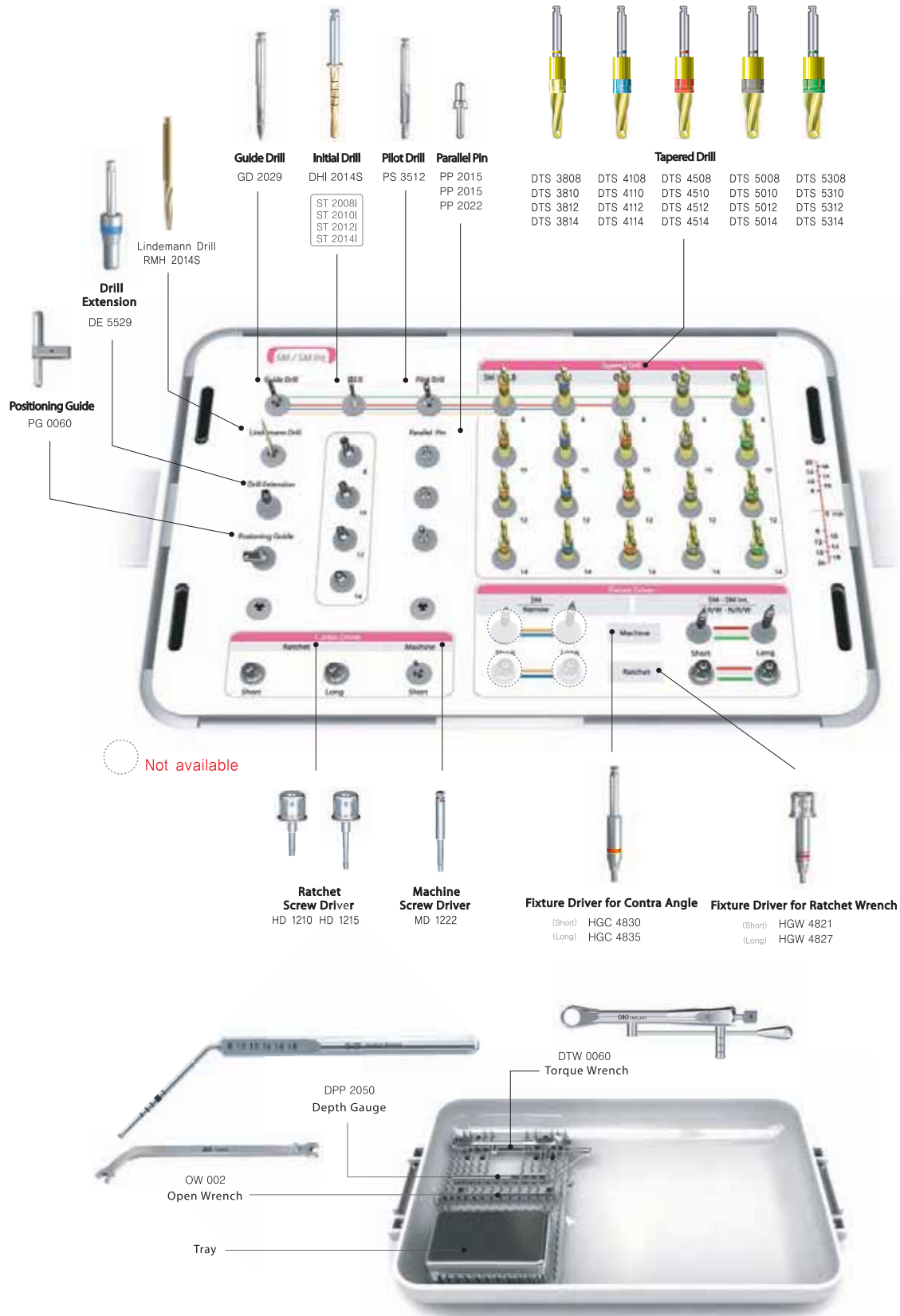

## Surgical Instruments

SM Implant System(SM-Internal)

### Guide Drill

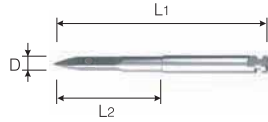

L1/L2	D	
		Ø2.0
25/11		GD 2025
29/15		GD 2029

- Used for drilling initial hole in bone tissue
- Bone density ascertainable during drilling

### Initial Drill

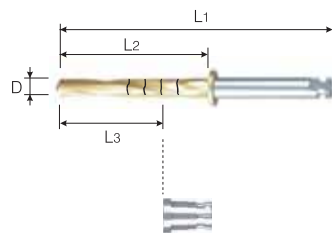

D	Ø2.0
L1	33
L2	18
Code	DHI 2014S
L3	Stopper
8	ST 2008I
10	ST 2010I
12	ST 2012I
14	ST 2014I

- L2 Laser marked

### Bone Planer

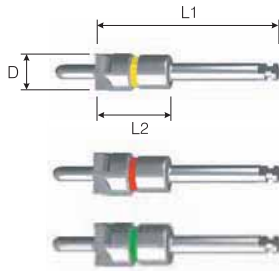

L1/L2	D	Ø4.95	Ø5.65	Ø5.9
24.5/10		BP 5010	BP 5710	BP 5910

- Creates a flat surface on bone
- Extracts desired bone with bone planer after initial drilling
- Handpiece speed: 400-600 rpm

### Drill Extension



L	Solid
29.7	DE 5529

- Provides extra length for drills used with handpieces
- Connects to the flat surface of the drill shank

### Lindemann Drill

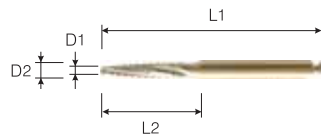

L1/L2	D1/D2	
		Ø1.4/Ø2.0
30/14		RMH 2014S

- Provides drill direction adjustment
- Useful in site preparation and ridge reduction in extractions

### Pilot Drill

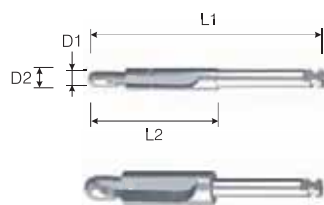

L1/L2	D1/D2	
		Ø2.0/Ø2.7
31/17		PS 3512
L1/L2	D1/D2	
		Ø3.0/Ø4.3
31/17		PS 4812

- Creates a path for drilling hole
- Creates accurate guide holes for the next step in surgical extraction

## Surgical Instruments

SM Implant System(SM-Internal)

### Tapered Drill

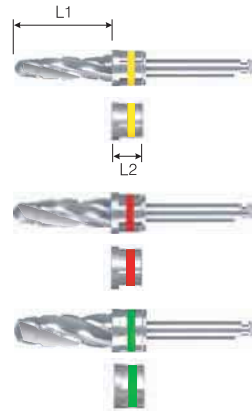

L1 \ Fixture Dia.	Ø3.5	Ø4.0	Ø4.8
8	DTI 3508S	DTI 4008S	DTI 4808S
10	DTI 3510S	DTI 4010S	DTI 4810S
12	DTI 3512S	DTI 4012S	DTI 4812S
14	DTI 3514S	DTI 4014S	DTI 4814S
L2	Stopper		
4	ST 3500I	ST 4000I	ST 4800I
3	ST 3501I	ST 4001I	ST 4801I

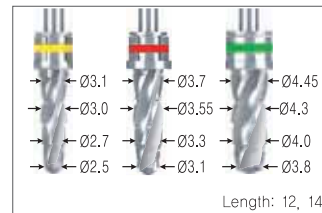
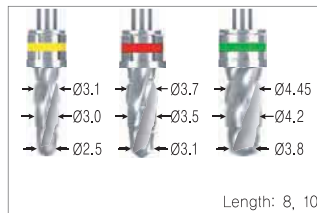

### Profile Drill

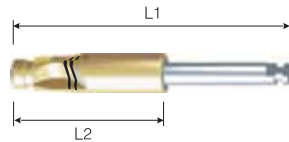

L1/L2 \ Fixture Dia.	Ø3.8	Ø4.5	Ø5.3
26.3/12.3	PFD 3805S	PFD 4505S	PFD 5305S
31.3/17.3	PFD 3810S	PFD 4510S	PFD 5310S
36.3/22.3	PFD 3815S	PFD 4515S	PFD 5315S

### SM Tapered Drill

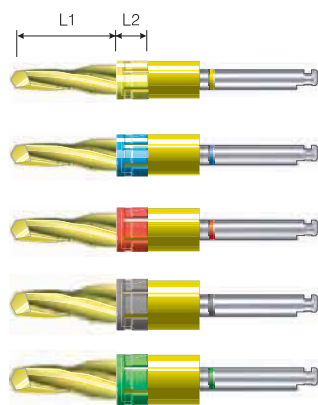

L1 \ Fixture Dia.	Ø3.8	Ø4.1	Ø4.5	Ø5.0	Ø5.3
8	DTS 3808	DTS 4108	DTS 4508	DTS 5008	DTS 5308
10	DTS 3810	DTS 4110	DTS 4510	DTS 5010	DTS 5310
12	DTS 3812	DTS 4112	DTS 4512	DTS 5012	DTS 5312
14	DTS 3814	DTS 4114	DTS 4514	DTS 5014	DTS 5314
L2	Stopper				
4	ST 3804	ST 4104	ST 4504	ST 5004	ST 5304
3	ST 3803	ST 4103	ST 4503	ST 5003	ST 5303

-SM Tapered Drill(Tapered drill + Profile drill)

### Tap Drill

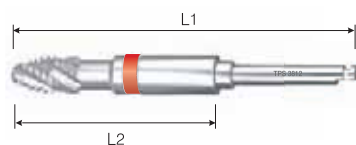

L1/L2 \ Fixture Dia.	Ø3.8	Ø4.1	Ø4.5	Ø5.0	Ø5.3
36.2/20.2	TPS 3812	TPS 4112	TPS 4512	TPS 5012	TPS 5312
41.2/25.2	TPS 3817	TPS 4117	TPS 4517	TPS 5017	TPS 5317

### Tap Adapter



L	5	TAPA 3011
	9.5	TAPA 3016

## Surgical Instruments

SM Implant System(SM-Internal)

### Positioning Guide

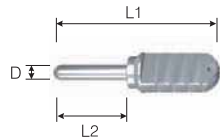

L	D	Ø2.0
7		PG 0060

- Marks space between fixtures
- Used after initial drilling

### Parallel Pin

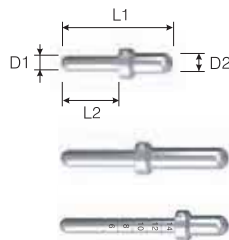

L1/L2	D1/D2	Ø2.0/Ø2.7
15/8		PP 2015
22/10		PP 2022
23/16		PP 2023

- Provides location and direction of site preparation
- Indicates the diameter of abutment and height of its collar
- Drill site depth survey
- Package Contents: Available as a part of a set or individual packaging

### Depth Gauge



D	Ø2.0
Code	DPP 2050

### Torque Wrench



Code	DTW 0060
------	----------

- Used in fixture implantation or screw repair
- Torque values (0, 15, 35, 50 Ncm) laser etched into the handle
- Convenient disassembly for easy cleaning

### Open Wrench



Code	OW 002
------	--------

- Used in removing mounts from weak bone tissue
- 30° neck angle for maximum comfort and ease of use

### Tissue Punch

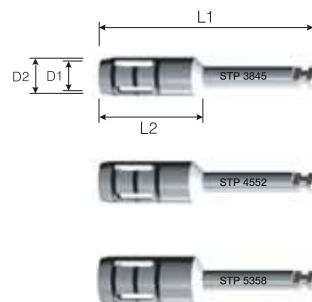

L1/L2	D1/D2	Ø3.8(Inner)/Ø4.5(Outer)
27/13		STP 3845

L1/L2	D1/D2	Ø4.5(Inner)/Ø5.2(Outer)
27/13		STP 4552

L1/L2	D1/D2	Ø5.3(Inner)/Ø5.8(Outer)
27/13		STP 5358

## Surgical Instruments

SM Implant System(SM-Internal)

### Machine Screw Driver



Type	L1/L2	Code
0.5 Slot	22/8	MD 0522
	30/16	MD 0530
0.9 Hex	22/8	MD 0922
	30/16	MD 0930
1.2 Hex	22/8	MD 1222
	30/16	MD 1230
1.7 Torx	22/8	MD 1722
	30/16	MD 1730

### Ratchet Screw Driver



Type	L	Code
0.5 Slot	10	HD 0510
	15	HD 0515
0.9 Hex	10	HD 0910
	15	HD 0915
	20	HD 0920
1.2 Hex	5	HD 1205
	10	HD 1210
	15	HD 1215
	20	HD 1220
1.7 Torx	10	HD 1710
	15	HD 1715
	20	HD 1720

### Ball Abutment Driver



L	Code
6	HD 2406
12	HD 2412

### Fixture Driver for Contra Angle

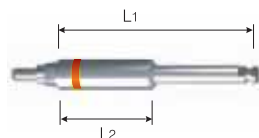

L1/L2	Code
21/6.9	HGC 4824
27/12.9	HGC 4830
32/17.9	HGC 4835

### Fixture Driver for Ratchet Wrench



L	Code
6	HGW 4813
14	HGW 4821
20	HGW 4827

## Surgical Instruments

SM Implant System(SM-Internal)

Fixture Mount Driver



L \ Type	M2.0	
18	HMDI 2018	
23	HMDI 2023	

Solid Abutment Driver



L \ D	Ø3.5	Ø4.3
6	HD 3506	HD 4306
12	HD 3512	HD 4312

Octa Abutment Driver



Type	L	Code
3.0 Octa	6	HD 3006
	12	HD 3012

Reamer Set



Reamer Cutter



Code	IRC 76
------	--------

Reamer Pin



D	Ø3.4	Ø4
Code	IRP 48	IRP 65

Trephine Drill

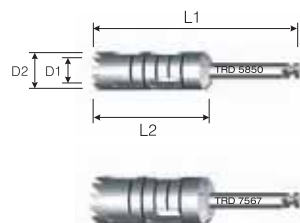

L1/L2 \ D1/D2	Ø5.0(Inner)/Ø5.8(Outer)
32/18	TRD 5850

L1/L2 \ D1/D2	Ø6.7(Inner)/Ø7.5(Outer)
32/18	TRD 7567

Ratcher Wrench



Code	DRW 050
------	---------



## Site Preparation

### Fixture Driver

Instructions for proper fixture driver use  
Remove driver from fixture only after adhesion

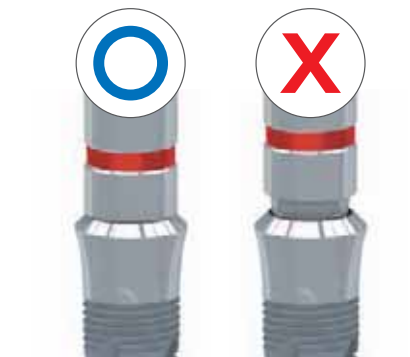

## Site Preparation

SM-Internal Fixture / Ø4.5mm(Length: 12mm)

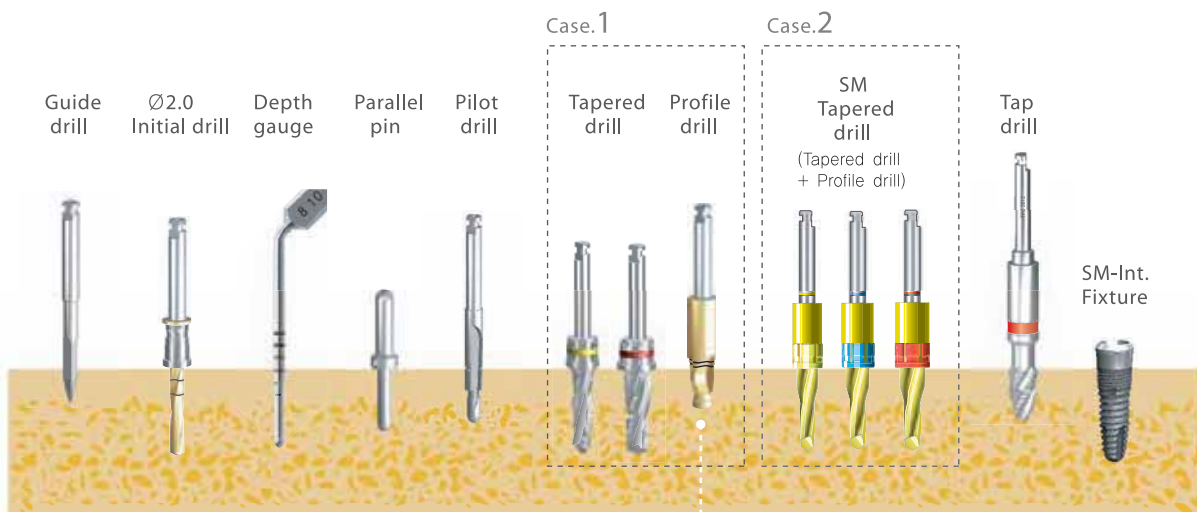

### Profile drill

Used to shape top of fixture (Straight & Taper shape)

Insertion depth: Drilling depth is determined by bone tissue.  
Drills up to B depth in case of D1/D2 bone.  
Tap drill is recommended in cases where the D1 bone tissue is resistant.  
Drills up to A depth in case of D2/D3 bone.  
Profile drill is not recommended in cases where the D4 bone tissue is weak.

This drill is designed to prevent excess torque.  
Implant depth is adjustable

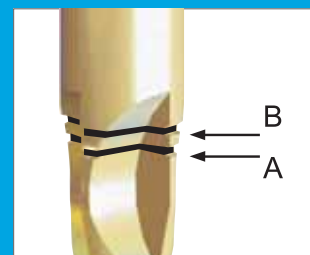

# IFI/SM Surgical Kit

Internal Implant System(IFI/SM)

Internal System

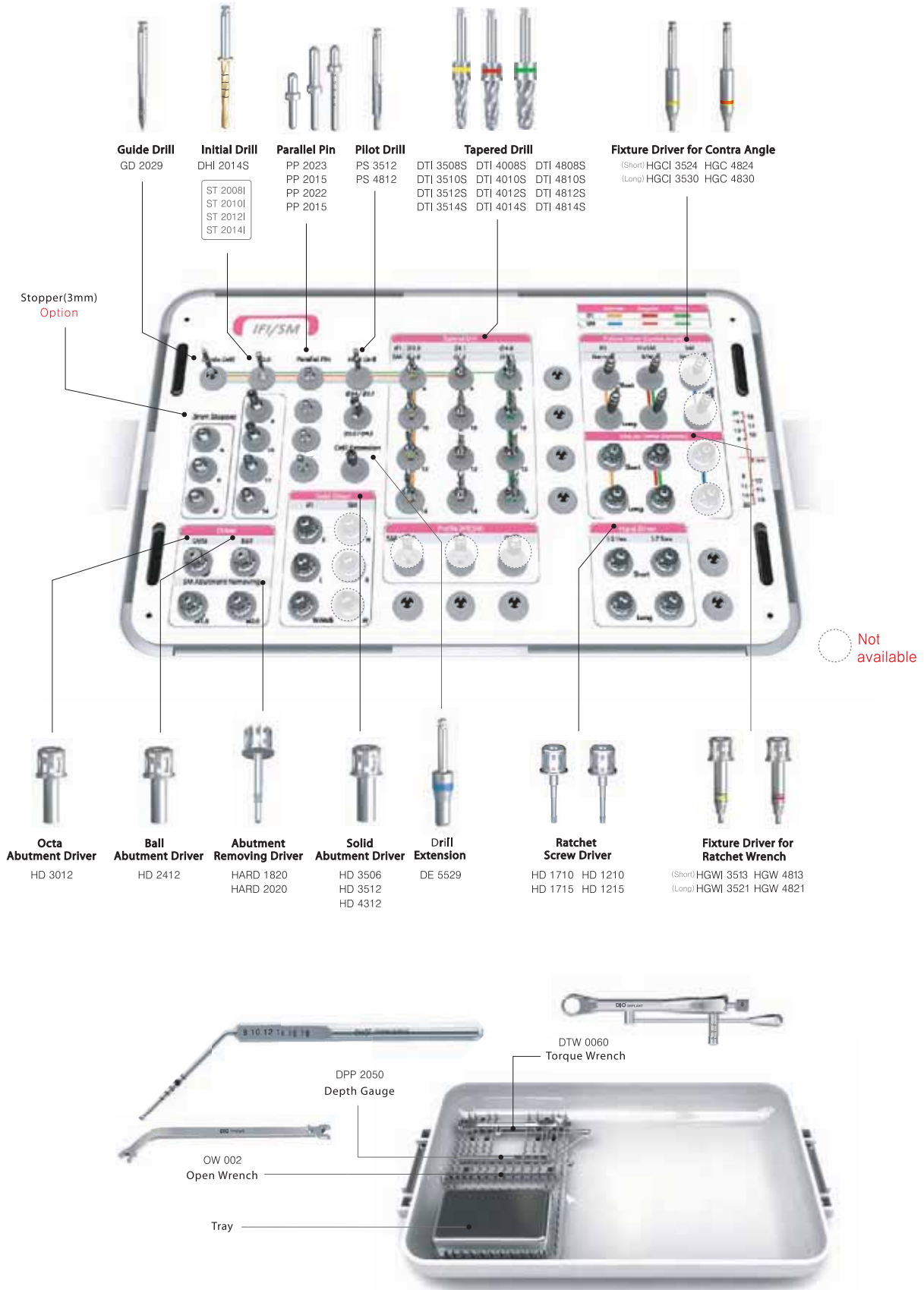

# PSI Surgical Kit

Internal Implant System(PSI)

Internal System

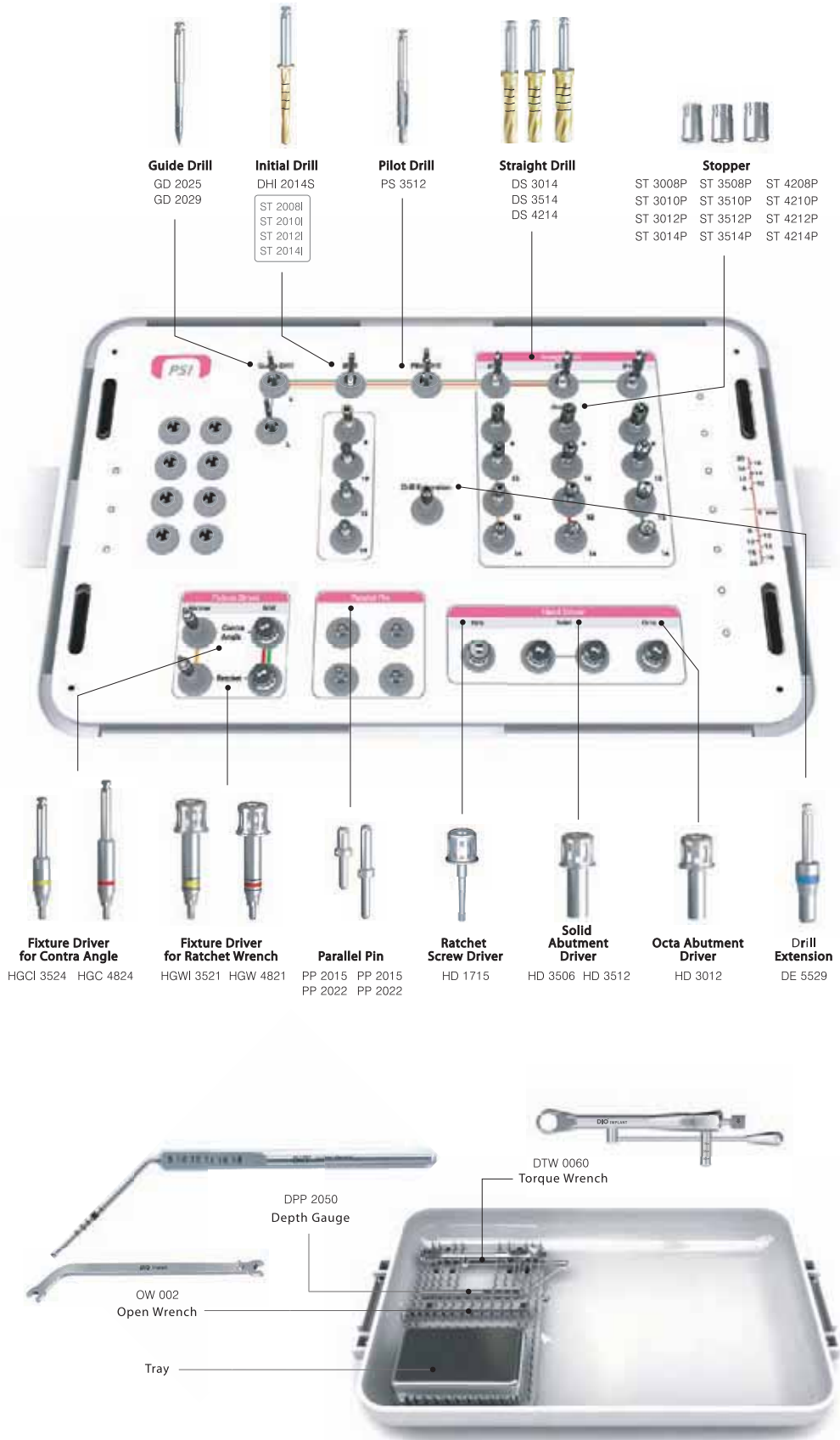

**Guide Drill**  
GD 2025  
GD 2029

**Initial Drill**  
DHI 2014S  
ST 2008I  
ST 2010I  
ST 2012I  
ST 2014I

**Pilot Drill**  
PS 3512

**Straight Drill**  
DS 3014  
DS 3514  
DS 4214

**Stopper**  
ST 3008P ST 3508P ST 4208P  
ST 3010P ST 3510P ST 4210P  
ST 3012P ST 3512P ST 4212P  
ST 3014P ST 3514P ST 4214P

**Fixture Driver for Contra Angle**  
HGCI 3524 HGC 4824

**Fixture Driver for Ratchet Wrench**  
HGWI 3521 HGW 4821

**Parallel Pin**  
PP 2015 PP 2015  
PP 2022 PP 2022

**Ratchet Screw Driver**  
HD 1715

**Solid Abutment Driver**  
HD 3506 HD 3512

**Octa Abutment Driver**  
HD 3012

**Drill Extension**  
DE 5529

**DPP 2050 Depth Gauge**  
**OW 002 Open Wrench**

**DTW 0060 Torque Wrench**

**Tray**

## Surgical Instruments

Internal Implant System (IFI/PSI)

### Guide Drill

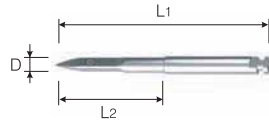

L1/L2	D	
		Ø2.0
25/11		GD 2025
29/15		GD 2029

–Used for drilling initial hole in bone tissue  
–Bone density ascertainable during drilling

### Initial Drill

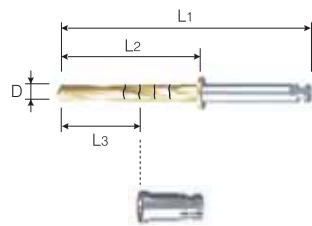

D	Ø2.0
L1	33.2
L2	18
Code	DHI 2014S
L3	Stopper
8	ST 2008I
10	ST 2010I
12	ST 2012I
14	ST 2014I

### Tapered Drill

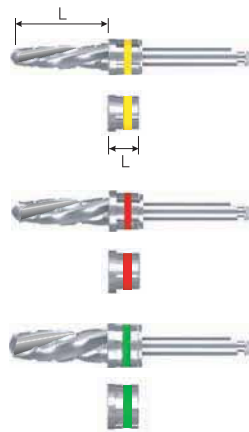

L	Fixture Dia.	Ø3.5	Ø4.0	Ø4.8
8		DTI 3508S	DTI 4008S	DTI 4808S
10		DTI 3510S	DTI 4010S	DTI 4810S
12		DTI 3512S	DTI 4012S	DTI 4812S
14		DTI 3514S	DTI 4014S	DTI 4814S
L		Stopper		
4		ST 3500I	ST 4000I	ST 4800I
3		ST 3501I	ST 4001I	ST 4801I

\*For use with IFI

### Straight Drill

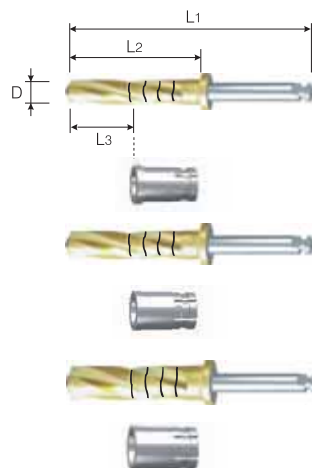

Code	DS 3014	DS 3514	DS 4214
D	Ø3.0	Ø3.5	Ø4.2
L1	33		
L2	18		
L3	Stopper		
8	ST 3008P	ST 3508P	ST 4208P
10	ST 3010P	ST 3510P	ST 4210P
12	ST 3012P	ST 3512P	ST 4212P
14	ST 3014P	ST 3514P	ST 4214P

\*For use with PSI

## Surgical Instruments

Internal Implant System (IFI/PSI)

### Straight Drill

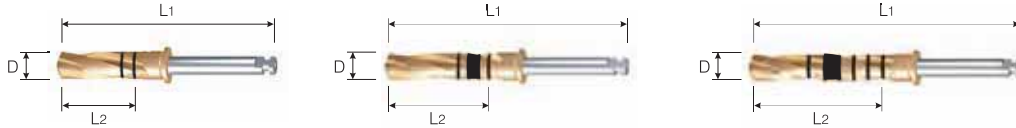

L1/L2 \ D	Ø2.7	Ø3.0	Ø3.3	Ø3.5	Ø3.8	Ø4.3	Ø4.8
24.5/10	SDS 2710A	SDS 3010A	SDS 3310A	SDS 3510A	SDS 3810A	SDS 4310A	SDS 4810A
28.5/14	SDS 2714A	SDS 3014A	SDS 3314A	SDS 3514A	SDS 3814A	SDS 4314A	SDS 4814A
32.5/18	SDS 2718A	SDS 3018A	SDS 3318A	SDS 3518A	SDS 3818A	SDS 4318A	SDS 4318A

\* For use with PSI

### Drill Extension



L	Code
29.7	DE 5529

- Provides extra length for drills used with handpieces
- Connects to the flat surface of the drill shank

### Lindemann Drill

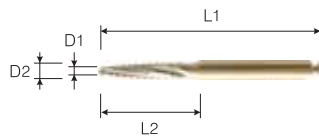

L1/L2 \ D1/D2	Ø1.4/Ø2.0
30/14	RMH 2014S

- Provides drill direction adjustment
- Useful in site preparation and ridge reduction in extractions

### Pilot Drill

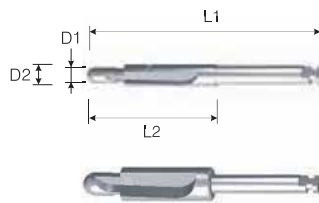

L1/L2 \ D1/D2	Ø2.0/Ø2.7
31/17	PS 3512

L1/L2 \ D1/D2	Ø3.0/Ø4.3
31/17	PS 4812

- Creates a path for drilling hole
- Creates accurate guide holes for the next step in surgical extraction

### Bone Planer

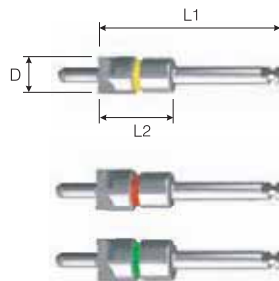

L1/L2 \ D	Ø4.95	Ø5.65	Ø5.9
24.5/10	BP 5010	BP 5710	BP 5910

- Creates a flat surface on bone
- Extracts desired bone with bone planer after initial drilling
- Handpiece speed: 400–600 rpm

## Surgical Instruments

### Internal Implant System (IFI/PSI)

Tap Drill

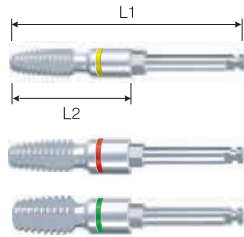

L1/L2	Fixture Dia.	Ø3.5	Ø4.0	Ø4.8
35/19		TPI 3512	TPI 4012	TPI 4812
40/24		TPI 3517	TPI 4017	TPI 4817

\*For use with IFI Fixture Tap

Positioning Guide

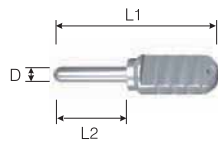

L1/L2	D	Ø2.0
22/10		PG 0050

- Marks space between fixtures
- Used after initial drilling

Parallel Pin

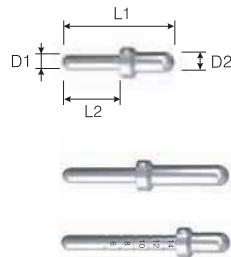

L1/L2	D1/D2	Ø2.0/Ø2.7
15/8		PP 2015
22/10		PP 2022
23/16		PP 2023

- Provides location and direction of site preparation
- Indicates the diameter of abutment and height of its collar
- Drill site depth survey
- Package Contents: Available as a part of a set or individual packaging

Path Pin

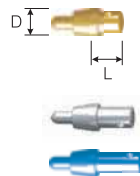

L	D	Ø3.5
4		PPI 3540
5.5		PPI 3555
7		PPI 3570

Angle Path Pin

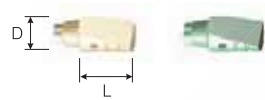

L	D	Ø3.5
6.2		AAN 015      AAW 015

Depth Gauge



D	Ø2.0
Code	DPP 2050

Torque Wrench



Code	DTW 0060
------	----------

- Used in fixture implantation or screw repair
- Torque values (0, 15, 35, 50 Ncm) laser etched into the handle
- Convenient disassembly for easy cleaning

## Surgical Instruments

Internal Implant System (IFI/PSI)

### Open Wrench



Code	OW 002
------	--------

- Used in removing mounts from weak bone tissue
- 30° neck angle for maximum comfort and ease of use

### Fixture Driver for Contra Angle



L1/L2	Code	
21/6.7	HGCI 3524	HGC 4824
27/12.7	HGCI 3530	HGC 4830
32/17.7	HGCI 3535	HGC 4835

### Fixture Driver for Ratchet Wrench



L	Code	
6.2	HGWI 3513	HGW 4813
14.2	HGWI 3521	HGW 4821
20.2	HGWI 3527	HGW 4827

### Fixture Mount Driver

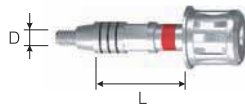

L	D	Ø2.0
12		HMDI 2012
18		HMDI 2018
23		HMDI 2023

### Machine Screw Driver

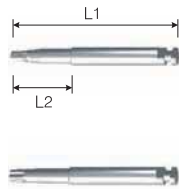

Type	L1/L2	Code
1.2 Hex	19/5	MD 1219
	22/8	MD 1222
	30/16	MD 1230
1.7 Torx	19/5	MD 1719
	22/8	MD 1722
	30/16	MD 1730

- Machine mounted screw driver
- No tip holding

### Ratchet Screw Driver

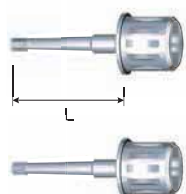

Type	L	Code
1.2 Hex	5	HD 1205
	10	HD 1210
	15	HD 1215
	20	HD 1220
1.7 Torx	10	HD 1710
	15	HD 1715
	20	HD 1720

- Torque adjusting driver

## Surgical Instruments

Internal Implant System (IFI/PSI)

### Solid Abutment Driver



L \ D	Ø3.5	Ø4.3
6	HD 3506	HD 4306
12	HD 3512	HD 4312

-For use with solid abutments  
-Torque confirmed only after driver is firmly engaged with the solid abutment groove

### Octa Abutment Driver



Type	L	Code
3.0 Octa	6	HD 3006
	12	HD 3012

-For use with Octa Abutment

### Ball Abutment Driver



Type	L	Code
Int. 2.4Hex	6	HD 2406
	12	HD 2412

-For use with Ball Abutment

### Reamer Set



### Reamer Cutter



Code	IRC 76

### Reamer Pin



D	Ø3.4	Ø4
Code	IRP 48	IRP 65

### Trepine Drill

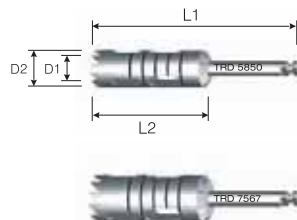

L1/L2 \ D1/D2	Ø5.0(Inner)/Ø5.8(Outer)
32/18	TRD 5850

L1/L2 \ D1/D2	Ø6.7(Inner)/Ø7.5(Outer)
32/18	TRD 7567

### Ratcher Wrench



Code	DRW 050



## Site Preparation

### IFI Fixture / Ø4.1mm(Length: 12mm)

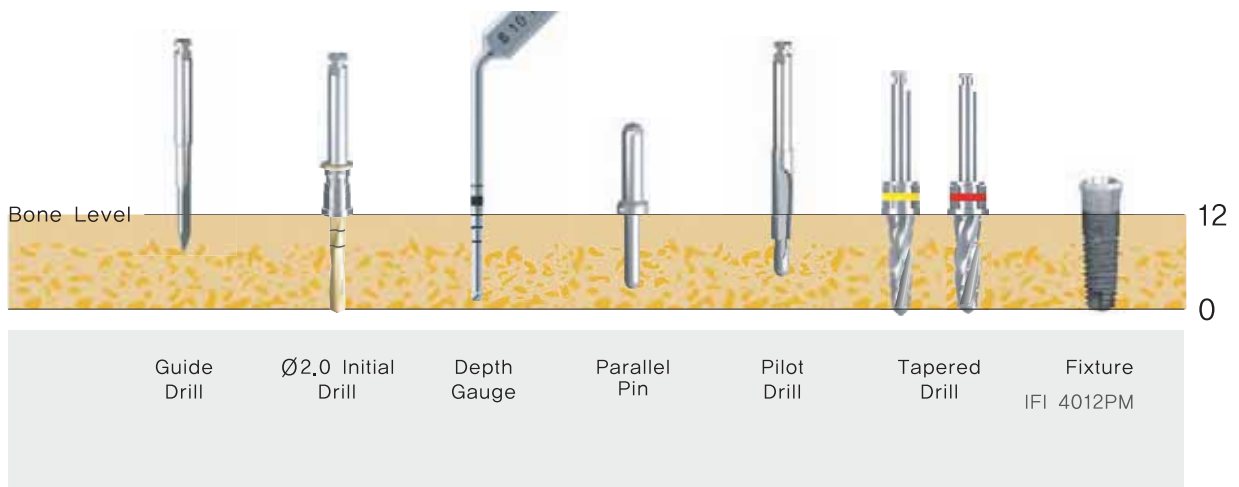

### PSI Fixture / Ø3.5mm(Length: 10mm)

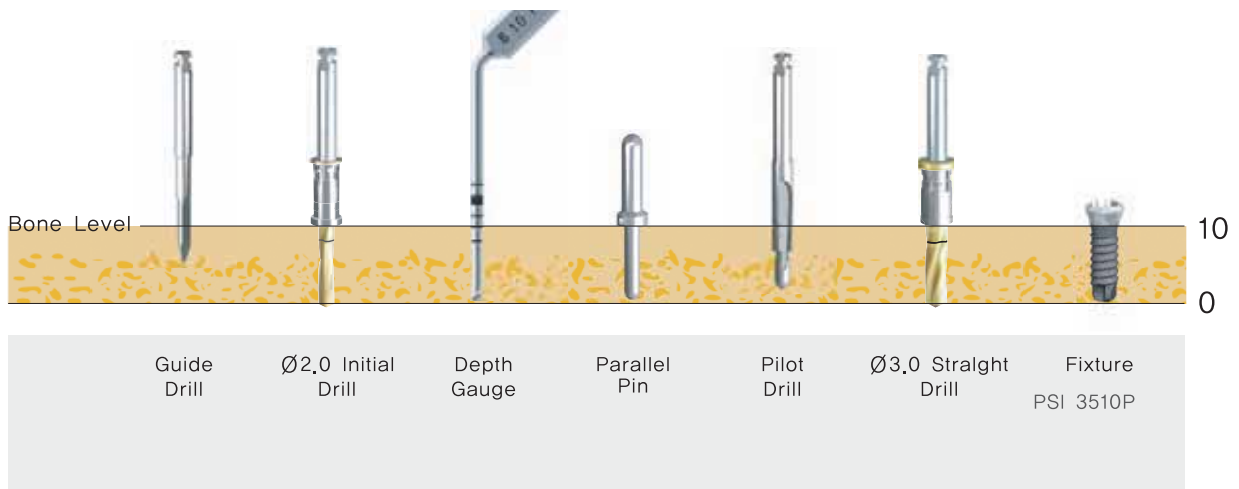



# Ext.

## External Implant System

SM-External / FSN / FTN



System Flowchart .....	094
Implants/Healing Abutments .....	098
(SM-External, FSN, FTN)	
Restorative Products .....	103
Surgical Kit	
Master Surgical Kit .....	119
Site Preparation (SM-External) .....	125
FSN Surgical Kit .....	126
FTN Surgical Kit .....	127
Site Preparation (FSN) .....	133
Site Preparation (FTN) .....	133

**DIO IMPLANT SYSTEM**

[www.dio.co.kr](http://www.dio.co.kr)

## External System Flowchart

Cement-Retained Restorations - Cemented Abutment

Cement-Retained Restorations - Angled Abutment

Screw-Retained Restorations - UCLA Abutment

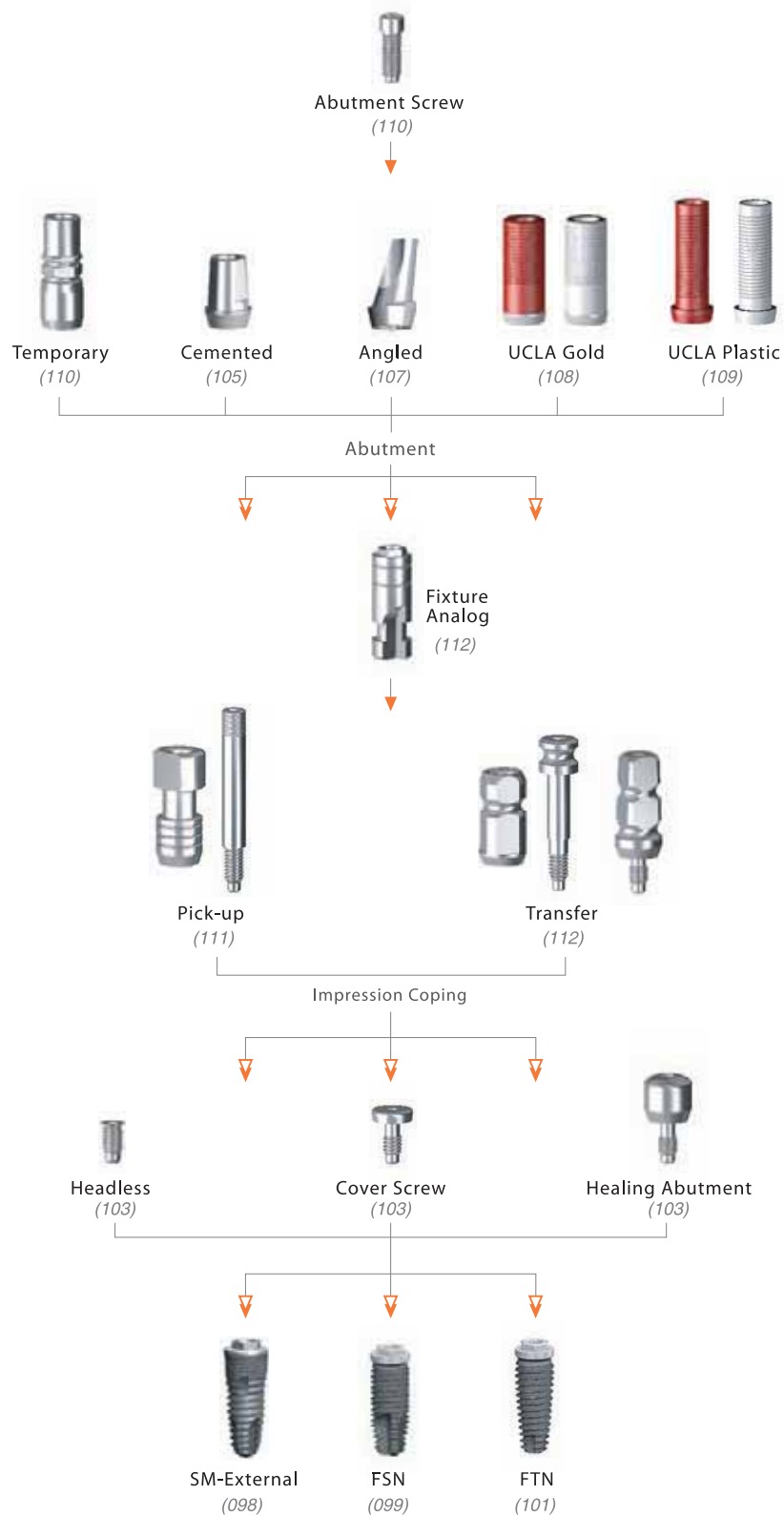

External System Flowchart

Screw-Retained Restorations - Conical Abutment(Long)

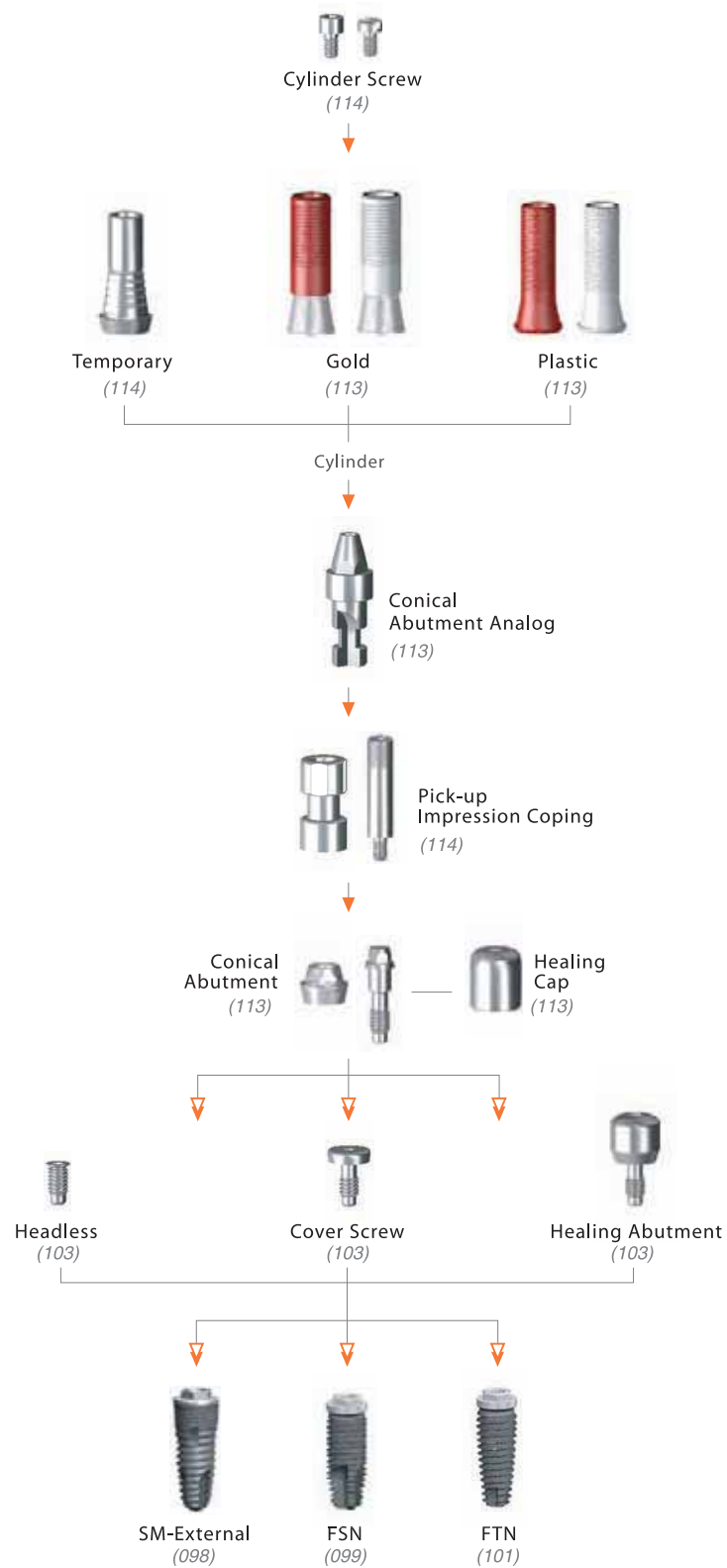

External System

External System Flowchart  
 Screw-Retained Restorations - Conical Abutment(Short)

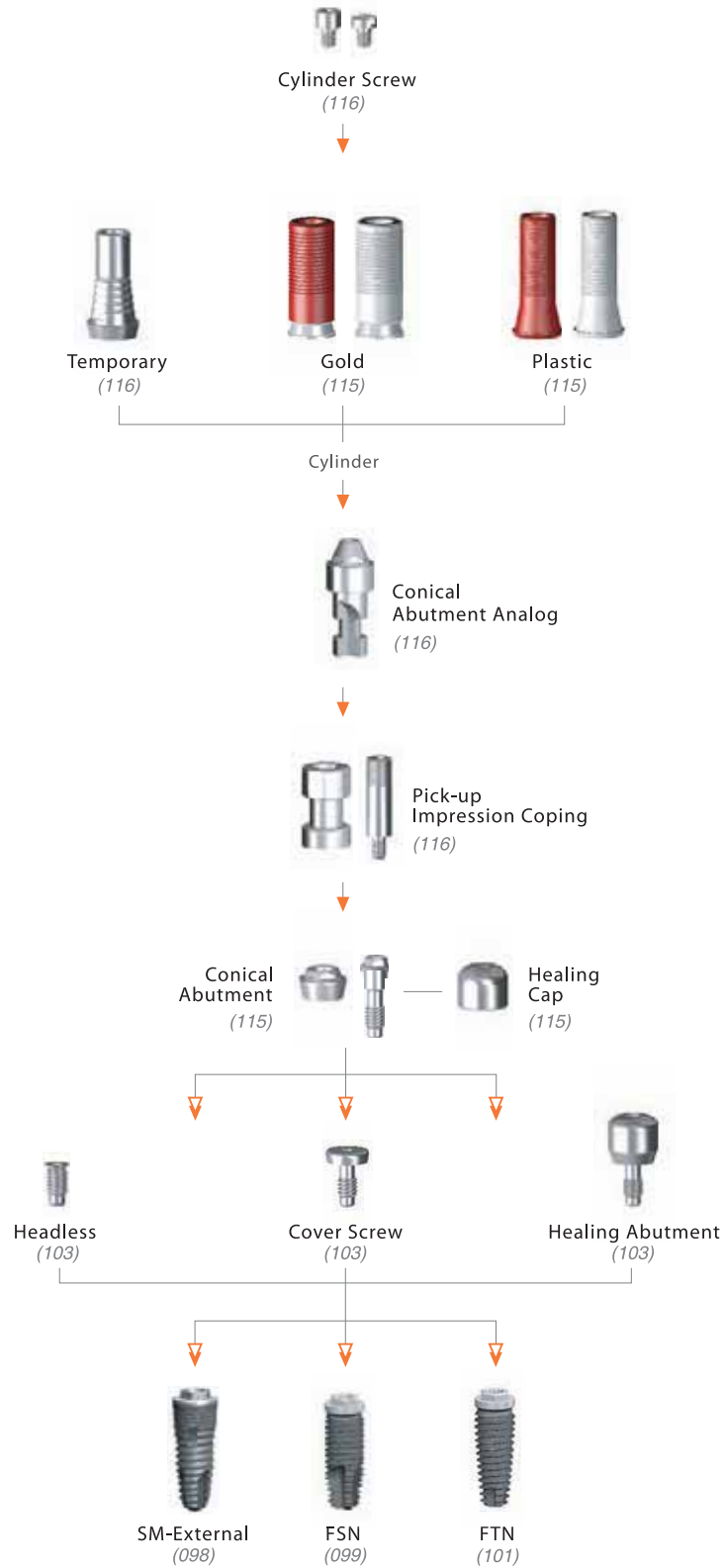

External System Flowchart

Overdenture-Retained Restorations - Ball Abutment

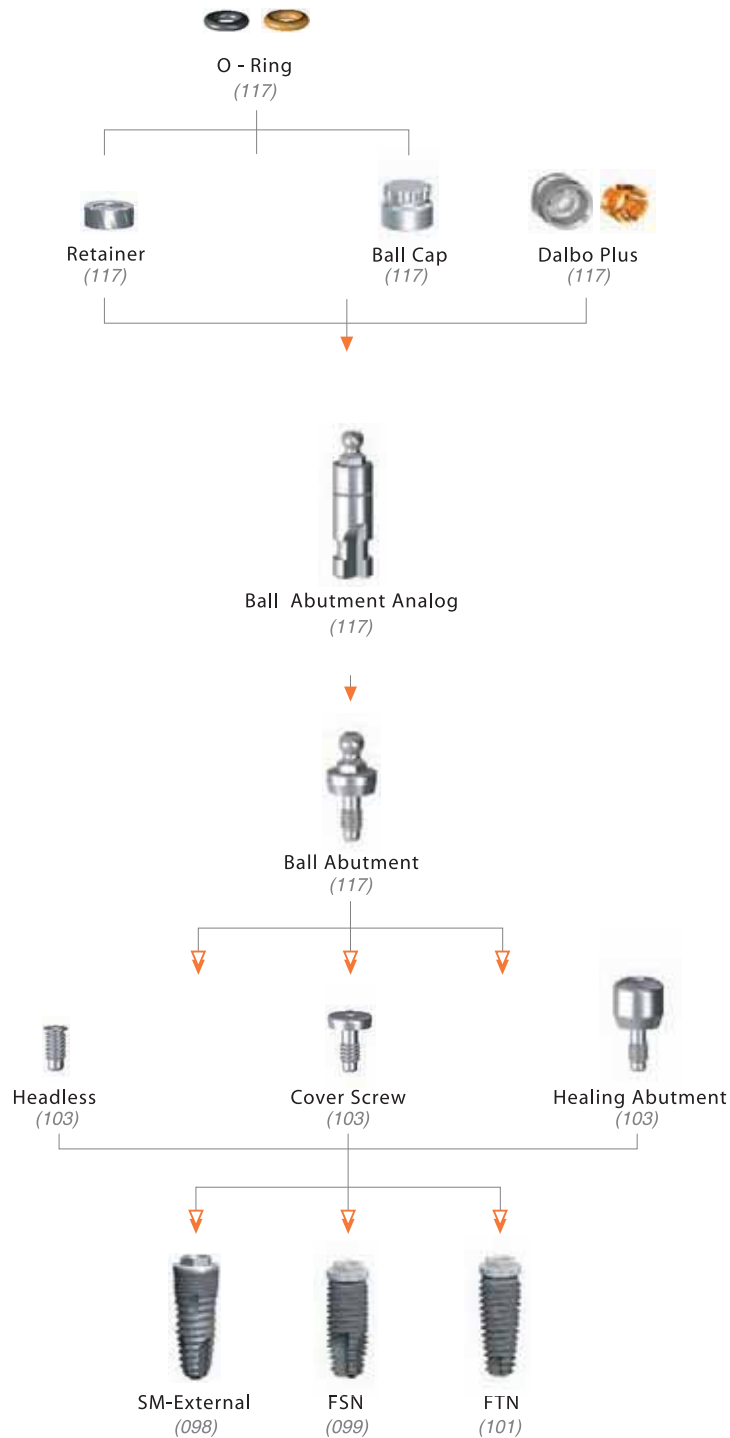

External System

## SM-External Fixture



- › External Hex Connection Submerged Type Implant
- › Platform Switching  
"Platform Switching" technique is applied to the design of the implants and abutments to reduce cretal bone loss
- › Double Thread  
Secure initial seating prevents cortical bone loss
- › Root Form Design  
Root form design enables excellent stability  
Reduces possibility of touching adjacent teeth root during implant insertion
- › Self Tapping  
Advanced thread and apex design enable easy self tapping and excellent initial stability in extraction sockets
- › Surface  
Biocompatible RBM
- › Compatibility with other external systems  
100% compatible with: FTN, FSN abutment products

### Narrow Platform Ø3.5

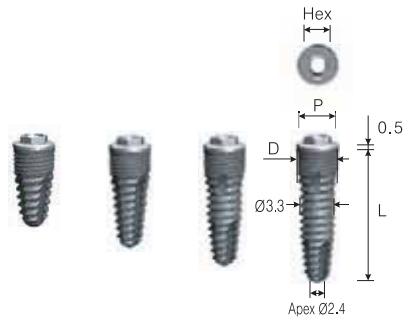

Length: 8 10 12 14

Hex	2.4
L \ D	Ø3.8
8	SEFN 3808
10	SEFN 3810
12	SEFN 3812
14	SEFN 3814

### Regular Platform Ø4.1

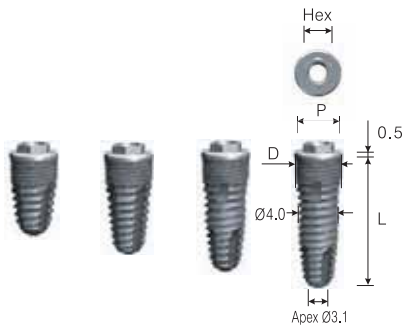

Length: 8 10 12 14

Hex	2.7
L \ D	Ø4.5
8	SEFR 4508
10	SEFR 4510
12	SEFR 4512
14	SEFR 4514

### Wide Platform Ø5.1



Length: 8 10 12 14

Hex	3.4
L \ D	Ø5.3
8	SEFW 5308
10	SEFW 5310
12	SEFW 5312
14	SEFW 5314



## External FSN Fixture



- › External Hex Connection Submerged Type Implant
- › Body Design
  - Straight design enables excellent initial stability
  - Reduces possibility of touching adjacent teeth root during implant insertion
- › Surface
  - Biocompatible RBM

### Narrow

Platform Ø3.5

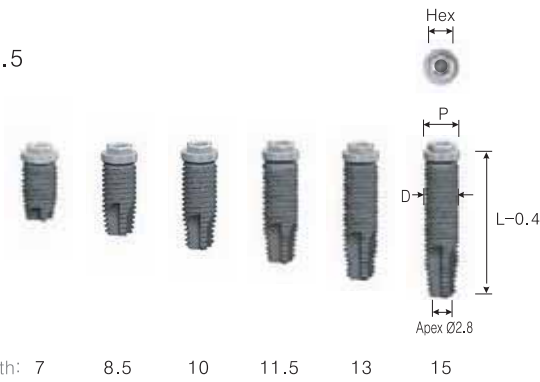

Hex	2.4
L \ D	Ø3.3
7	FSN 3307B
8.5	FSN 3308B
10	FSN 3310B
11.5	FSN 3311B
13	FSN 3313B
15	FSN 3315B

### Regular

Platform Ø4.1

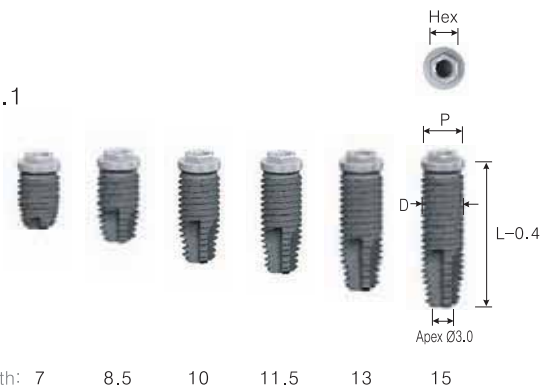

Hex	2.7
L \ D	Ø3.75
7	FSN 3707B
8.5	FSN 3708B
10	FSN 3710B
11.5	FSN 3711B
13	FSN 3713B
15	FSN 3715B

Platform Ø4.1

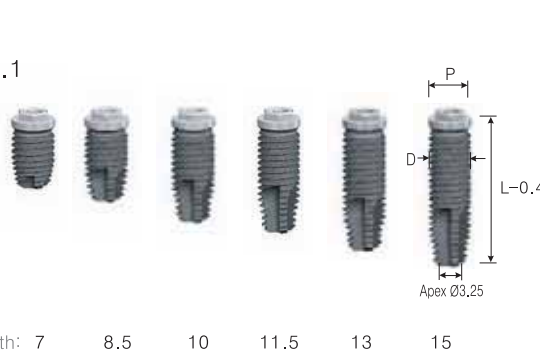

Hex	2.7
L \ D	Ø4.0
7	FSN 4007B
8.5	FSN 4008B
10	FSN 4010B
11.5	FSN 4011B
13	FSN 4013B
15	FSN 4015B

Wide

Platform Ø5.1

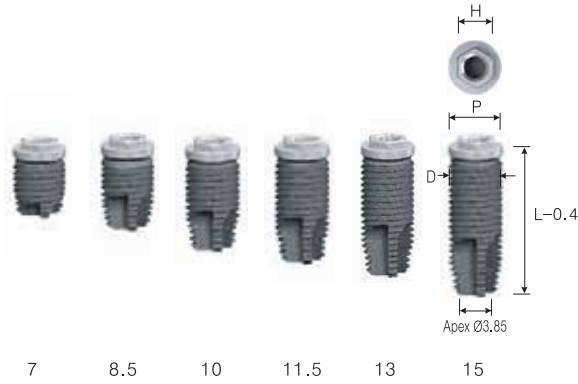

Hex	3.4
L \ D	Ø5.0
7	FSN 5007B
8.5	FSN 5008B
10	FSN 5010B
11.5	FSN 5011B
13	FSN 5013B
15	FSN 5015B

Platform Ø5.1



Hex	3.4
L \ D	Ø5.5
7	-
8.5	FSN 5508B
10	FSN 5510B
11.5	FSN 5511B
13	FSN 5513B
15	FSN 5515B

Platform Ø5.1



Hex	3.4
L \ D	Ø6.0
7	-
8.5	FSN 6008B
10	FSN 6010B
11.5	FSN 6011B
13	FSN 6013B
15	FSN 6015B

T-Wide

Platform Ø5.0

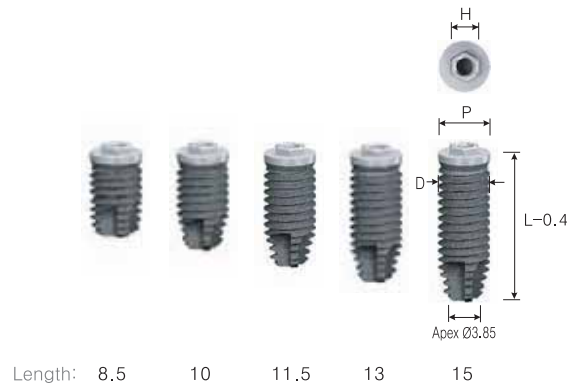

Hex	2.7
L \ D	Ø5.0
8.5	FST 5008B
10	FST 5010B
11.5	FST 5011B
13	FST 5013B
15	FST 5015B

## External FTN Fixture



### › External Hex Connection Submerged Type Implant

#### › Body Design

Root form design enables excellent initial stability  
Reduces possibility of touching adjacent teeth root during implant insertion

#### › Self Tapping

Advanced thread and apex design enable easy self tapping and excellent initial stability in extraction sockets

#### › Surface

Biocompatible RBM

### Narrow

Platform  $\varnothing 3.5$



Length: 8.5 10 11.5 13 15

Hex	2.4
L \ D	$\varnothing 3.3$
8.5	FTN 3308B
10	FTN 3310B
11.5	FTN 3311B
13	FTN 3313B
15	FTN 3315B

### Regular

Platform  $\varnothing 4.1$



Length: 8.5 10 11.5 13 15

Hex	2.7
L \ D	$\varnothing 4.0$
8.5	FTN 4008B
10	FTN 4010B
11.5	FTN 4011B
13	FTN 4013B
15	FTN 4015B

Wide  
Platform Ø5.1



Length: 8.5    10    11.5    13    15

Hex	3.4
L \ D	Ø5.0
8.5	FTN 5008B
10	FTN 5010B
11.5	FTN 5011B
13	FTN 5013B
15	FTN 5015B

Platform Ø5.1



Length: 8.5    10    11.5    13    15

Hex	3.4
L \ D	Ø5.5
8.5	FTN 5508B
10	FTN 5510B
11.5	FTN 5511B
13	FTN 5513B
15	FTN 5515B

T-Wide  
Platform Ø5.0



Length: 8.5    10    11.5    13    15

Hex	2.7
L \ D	Ø5.0
8.5	FTT 5008B
10	FTT 5010B
11.5	FTT 5011B
13	FTT 5013B
15	FTT 5015B

Cover Screw

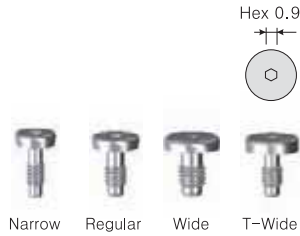

Platform	Ø3.5	Ø4.1	Ø5.1	Ø5.0
Code	CHN 3501	CHN 4001	CHN 5001	CHT 5001

- Uses 0,9 Hex Driver
- Package Contents: Cover Screw
- Tightening Torque: 5-8 Ncm

Headless

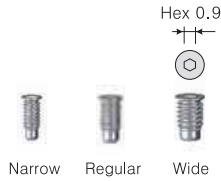

Code	CHN 3500N	CHN 4000N	CHN 5000N
------	-----------	-----------	-----------

- For use in restrictive spaces and difficulty closing sutures in gingiva
- Uses 0,9 Hex Driver
- Compatible with Regular and T-Wide
- Package Contents: Headless
- Tightening Torque: 5-8 Ncm



Healing Abutment

Platform	Ø3.5	Ø4.1		Ø5.1	Ø5.0
L \ D	Ø4.0	Ø5.0	Ø6.0	Ø6.0	Ø6.0
2	AHN 35402	AHN 40502	AHN 40602	AHN 50602	AHT 50602
3	AHN 35403	AHN 40503	AHN 40603	AHN 50603	AHT 50603
4	AHN 35404	AHN 40504	AHN 40604	AHN 50604	AHT 50604
5	AHN 35405	AHN 40505	AHN 40605	AHN 50605	AHT 50605
6	AHN 35406	AHN 40506	AHN 40606	AHN 50606	AHT 50606
8	AHN 35408	AHN 40508	AHN 40608	AHN 50608	AHT 50608

- Packing Contents: Healing Abutment
- Tightening Torque: 5~8Ncm
- Uses 1,2Hex Driver

## Abutments for External Implant System

---



Ball Abutment  
(117)



Gold Cylinder  
(Long)  
(113)



Conical Abutment  
(Long)  
(113)



Gold Cylinder  
(Short)  
(115)



Conical Abutment  
(Short)  
(115)



UCLA Plastic Abutment  
(109)



UCLA Gold Abutment  
(108)



Cemented Abutment  
(104)



Angled Abutment  
(107)

**Cemented Abutment**

- Used in fabricating standard cement type prosthesis
- Taper Body Design for precise connection with prosthetic
- Prosthetic rotation prevention
- Uses 1.7 Torx Driver
- Package Contents: Abutment + Abutment Screw
- Tightening Torque: 35 Ncm

**Narrow**

Platform Ø3.5



C	D	Ø4.0	
		Type	
		Hex	Non-Hex
1	4	AMN 35415	AMN 35415N
	5.5	AMN 35416	AMN 35416N
	7	AMN 35418	AMN 35418N
2	4	AMN 35426	AMN 35426N
	5.5	AMN 35427	AMN 35427N
	7	AMN 35429	AMN 35429N
3	4	AMN 35437	AMN 35437N
	5.5	AMN 35438	AMN 35438N
	7	AMN 35430	AMN 35430N
4	4	AMN 35448	AMN 35448N
	5.5	AMN 35449	AMN 35449N
	7	AMN 35441	AMN 35441N

**Regular**

Platform Ø4.1



C	D	Ø5.0	
		Type	
		Hex	Non-Hex
1	4	AMN 40515	AMN 40515N
	5.5	AMN 40516	AMN 40516N
	7	AMN 40518	AMN 40518N
2	4	AMN 40526	AMN 40526N
	5.5	AMN 40527	AMN 40527N
	7	AMN 40529	AMN 40529N
3	4	AMN 40537	AMN 40537N
	5.5	AMN 40538	AMN 40538N
	7	AMN 40530	AMN 40530N
4	4	AMN 40548	AMN 40548N
	5.5	AMN 40549	AMN 40549N
	7	AMN 40541	AMN 40541N

External System

**Regular**

Platform Ø4.1



C	D		Ø6.0	
	L	Type	Hex	Non-Hex
1	4		AMN 40615	AMN 40615N
	5.5		AMN 40616	AMN 40616N
	7		AMN 40618	AMN 40618N
2	4		AMN 40626	AMN 40626N
	5.5		AMN 40627	AMN 40627N
	7		AMN 40629	AMN 40629N
3	4		AMN 40637	AMN 40637N
	5.5		AMN 40638	AMN 40638N
	7		AMN 40630	AMN 40630N
4	4		AMN 40648	AMN 40648N
	5.5		AMN 40649	AMN 40649N
	7		AMN 40641	AMN 40641N

**Wide**

Platform Ø5.1



C	D		Ø6.0	
	L	Type	Hex	Non-Hex
1	4		AMN 50615	AMN 50615N
	5.5		AMN 50616	AMN 50616N
	7		AMN 50618	AMN 50618N
2	4		AMN 50626	AMN 50626N
	5.5		AMN 50627	AMN 50627N
	7		AMN 50629	AMN 50629N
3	4		AMN 50637	AMN 50637N
	5.5		AMN 50638	AMN 50638N
	7		AMN 50630	AMN 50630N
4	4		AMN 50648	AMN 50648N
	5.5		AMN 50649	AMN 50649N
	7		AMN 50641	AMN 50641N

**T-Wide**

Platform Ø5.0



C	D		Ø6.0	
	L	Type	Hex	Non-Hex
1	4		AMT 50615	AMT 50615N
	5.5		AMT 50616	AMT 50616N
	7		AMT 50618	AMT 50618N
2	4		AMT 50626	AMT 50626N
	5.5		AMT 50627	AMT 50627N
	7		AMT 50629	AMT 50629N
3	4		AMT 50637	AMT 50637N
	5.5		AMT 50638	AMT 50638N
	7		AMT 50630	AMT 50630N
4	4		AMT 50648	AMT 50648N
	5.5		AMT 50649	AMT 50649N
	7		AMT 50641	AMT 50641N



**Angled Abutment**

- For use in situations where prosthetic path needs adjustment
- Double Hex connection provides abutment adjustment control
- Uses 1,7 Torx Driver
- Package Contents: Abutment + Abutment Screw
- Tightening Torque: 35 Ncm

**Narrow**

Platform Ø3,5



Angle	C \ D	Ø4.0
15°	2	AAN 35215
	4	AAN 35415
25°	2	AAN 35225
	4	AAN 35425

**Regular**

Platform Ø4.1



Angle	C \ D	Ø5.0
15°	2	AAN 40215
	4	AAN 40415
25°	2	AAN 40225
	4	AAN 40425

**Wide**

Platform Ø5.1



Angle	C \ D	Ø6.0
15°	2	AAN 50215
	4	AAN 50415
25°	2	AAN 50225
	4	AAN 50425

**T-Wide**

Platform Ø5.0



Angle	C \ D	Ø6.0
15°	2	AAT 50215
	4	AAT 50415
25°	2	AAT 50225
	4	AAT 50425

External System

**UCLA Gold Abutment**

- Used for superior aesthetics and precision
- Gold casting for ultimate customization
- Abutment Melting Point: 1400-1450°C (results may vary by casting machine)
- Uses 1,7 Torx Driver
- Package Contents: Abutment + Abutment Screw
- Tightening Torque: 35 Ncm

**Narrow**

Platform Ø3.5



D	Ø4.0
Type \ L	11
Hex	AGN 35414
Non-Hex	AGN 35414N

**Regular**

Platform Ø4.1



D	Ø4.5
Type \ L	11
Hex	AGN 40514
Non-Hex	AGN 40514N

**Wide**

Platform Ø5.1

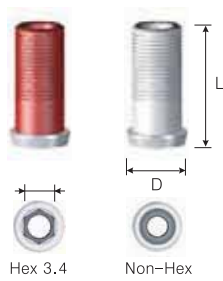

D	Ø5.5
Type \ L	11
Hex	AGN 50614
Non-Hex	AGN 50614N

**T-Wide**

Platform Ø5.0

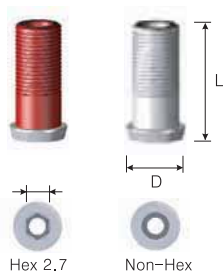

D	Ø5.5
Type \ L	10
Hex	AGT 50614
Non-Hex	AGT 50614N

**UCLA Plastic Abutment**

- Used for superior aesthetics and customization
- Gold casting for ultimate customization
- Less precise than the UCLA Gold Abutment
- Uses 1,7 Torx Driver
- Package Contents: Abutment + Abutment Screw
- Tightening Torque: 35 Ncm

**Narrow**

Platform Ø3.5

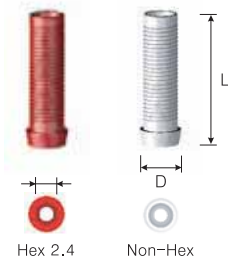

D	Ø4.0
Type \ L	13
Hex	APN 35413
Non-Hex	APN 35413N

**Regular**

Platform Ø4.1

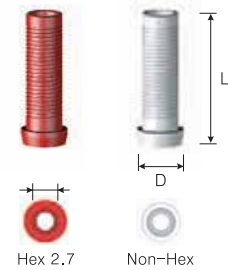

D	Ø4.5
Type \ L	13
Hex	APN 40513
Non-Hex	APN 40513N

**Wide**

Platform Ø5.1

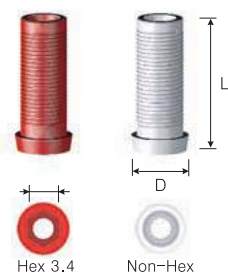

D	Ø5.5
Type \ L	13
Hex	APN 50613
Non-Hex	APN 50613N

**T-Wide**

Platform Ø5.0

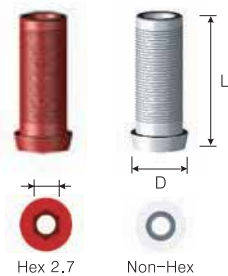

D	Ø5.5
Type \ L	13
Hex	APT 50613
Non-Hex	APT 50613N

External System

Temporary Abutment

- Used for fabricating temporary prosthetics
- Simple customization
- Minimizes restriction while in use
- Uses 1,7 Torx Driver
- Package Contents: Abutment + Abutment Screw
- Tightening Torque: 35 Ncm

**Narrow**

Platform Ø3.5



D	Ø4.0
Type \ L	12
Hex	TMN 35412
Non-Hex	TMN 35412N

**Regular**

Platform Ø4.1

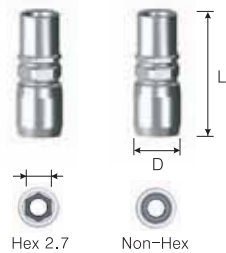

D	Ø4.5
Type \ L	12
Hex	TMN 40512
Non-Hex	TMN 40512N

**Wide**

Platform Ø5.1



D	Ø5.5
Type \ L	12
Hex	TMN 50612
Non-Hex	TMN 50612N

**T-Wide**

Platform Ø5.0

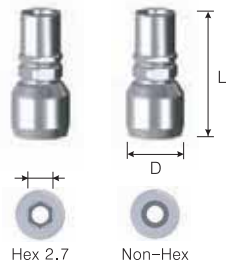

D	Ø5.5
Type \ L	12
Hex	TMT 50612
Non-Hex	TMT 50612N

Abutment Screw



Code	STN 1608	STN 2008	STN 2508
------	----------	----------	----------

\*T-Wide : STN 2008

**Pick-up Impression Coping**

- Used for pick-up impressions with custom trays
- Minimizes distortion
- Long and short compositions available
- Uses 1,2 Hex Driver
- Package Contents: Impression Coping Body + Guide Pin

**Narrow**

Platform Ø3.5



D	Ø3.8	
Type \ L	8	12
Hex	IPN 3508	IPN 35412
Non-Hex	IPN 3508N	IPN 35412N

**Regular**

Platform Ø4.1



D	Ø4.8	
Type \ L	8	12
Hex	IPN 4008	IPN 40512
Non-Hex	IPN 4008N	IPN 40512N

**Wide**

Platform Ø5.1

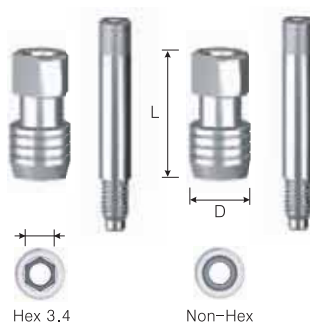

D	Ø5.8	
Type \ L	8	12
Hex	IPN 5008	IPN 50612
Non-Hex	IPN 5008N	IPN 50612N

**T-Wide**

Platform Ø5.0



D	Ø5.8	
Type \ L	8	12
Hex	IPT 5008	IPT 50612
Non-Hex	IPT 5008N	IPT 50612N

External System

**Transfer Impression Coping**

–Used for Transfer Type impressions with custom trays  
 –Hex Type, two-piece construction; Non-Hex Type, one-piece construction  
 –Package Contents: Impression Coping Body + Guide Pin (Hex); Impression Coping (Non-Hex)

**Narrow**

Platform Ø3.5



D		Ø3.8	
Type	L	13	11
Hex		ITN 35412H	-
Non-Hex		-	ITN 35412

**Regular**

Platform Ø4.1



D		Ø5.0	
Type	L	13	11
Hex		ITN 40512H	-
Non-Hex		-	ITN 40512

**Wide**

Platform Ø5.1



D		Ø6.0	
Type	L	12	11
Hex		ITN 50612H	-
Non-Hex		-	ITN 50612

**T-Wide**

Platform Ø5.0



D		Ø6.0	
Type	L	9.5	11
Hex		ITT 50612H	-
Non-Hex		-	ITT 50612

**Fixture Analog**



Platform	3.5	4.1	5.1	5.0
Hex	2.4	2.7	3.4	2.7
Code	RMN 35312	RMN 40412	RMN 50512	RMT 50512

–Provides anchor point for fixtures  
 –Package Contents: Analog

Conical Abutment

Platform Ø4.1



C \ D	Ø4.8
1	ACN 40513
2	ACN 40524
3	ACN 40535
4	ACN 40546

- Maintains screw and prosthetic aesthetics
- For fabrication of prosthetic on cylinder after abutment has been placed
- Up to 30° path angle
- Uses 2,0 Internal Conical Abutment Driver
- Package Contents: Abutment + Abutment Screw
- Tightening Torque: 35 Ncm

Healing Cap

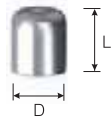

L \ D	Ø4.8
6	HCN 40506

- Protects the Conical Abutment and promotes patient healing
- Uses 1,2 Hex Driver
- Package Contents: Healing Cap
- Tightening Torque: 20 Ncm

Gold Cylinder

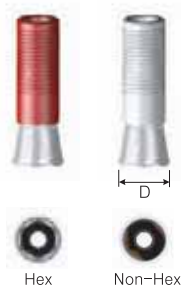

Type \ D	Ø5.0
Hex	AGN 40506
Non-Hex	AGN 40506N

- Cast in premium gold alloy after customization
- Cylinder melting point: 1400–1450° C (may vary with casting machine)
- Uses 1,2 Hex Driver
- Package Contents: Cylinder + Cylinder Screw
- Tightening Torque: 20 Ncm

Plastic Cylinder

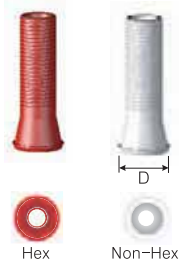

Type \ D	Ø5.0
Hex	APN 40514
Non-Hex	APN 40514N

- Cast in premium gold alloy after customization
- Less precise than the gold cylinder
- Uses 1,2 Hex Driver
- Package Contents: Cylinder + Cylinder Screw
- Tightening Torque: 20 Ncm

Temporary Cylinder



D	Ø5.4	
L \ Type	Hex	Non-Hex
12	TCN 40512	TCN 40512N

- For fabricating temporary prosthetics on top of Conical Abutments
- Simple customization
- Minimizes restriction while in use
- Uses 1,2 Hex Driver
- Package Contents: Cylinder + Cylinder Screw
- Tightening Torque: 20 Ncm

Pick-up Impression Coping

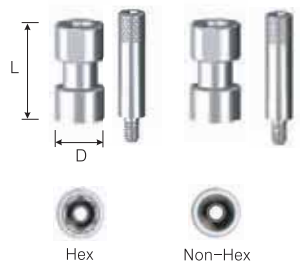

D	Ø4.8	
L \ Type	Hex	Non-Hex
9.4	IPN 40510	IPN 40510N

- Create final impression of Conical Abutment on impression coping
- For use with pick-up type custom trays
- Package Contents: Impression Coping + Guide Pin

Conical Abutment Analog



L \ D	Ø4.8
14	RCN 40414

- Provides anchor point for Conical Abutment
- Package Contents: Analog

Cylinder Screw

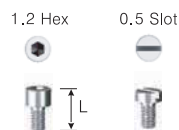

L \ Type	1.2 Hex	0.5 Slot
4.3	SHN 1404	-
3.7	-	SSN 1404



Conical Abutment

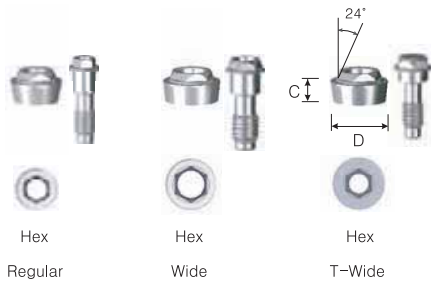

D	Ø4.8	Ø5.5	
C / F/P	Ø4.1	Ø5.1	Ø5.0
1	ACN 40512	ACN 50612	ACT 50612
2	ACN 40523	ACN 50623	ACT 50623
3	ACN 40534	ACN 50634	ACT 50634
4	ACN 40545	ACN 50645	ACT 50645

- For fabricating temporary prosthetics on top of Conical Abutments
- Simple customization
- Minimizes restriction while in use
- Uses 1,2 Hex Driver
- Package Contents: Cylinder + Cylinder Screw
- Tightening Torque: 35Ncm

Healing Cap

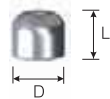

L / D	Ø5.0	Ø5.8
4.5	HCN 40504	-
4.6	-	HCN 50604

- Create final impression of Conical Abutment on impression coping
- For use with pick-up type custom trays
- Package Contents: Impression Coping + Guide Pin

External System

Gold Cylinder



D	Ø5.0	Ø6.0
Type / L	12	12
Hex	AGN 40504	AGN 50604
Non-Hex	AGN 40504N	AGN 50604N

- Provides anchor point for Conical Abutment
- Package Contents: Analog

Plastic Cylinder

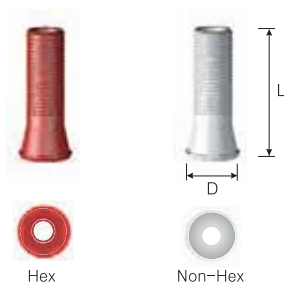

D	Ø5.0	Ø6.0
Type / L	13	13
Hex	APN 40514S	APN 50614
Non-Hex	APN 40514SN	APN 50614N

Temporary Cylinder



D	Ø5.4	Ø6.0
Type \ L	11	11
Hex	TCN 40511	TCN 50611
Non-Hex	TCN 40511N	TCN 50611N

- For fabricating temporary prosthetics on top of Conical Abutments
- Simple customization
- Minimizes restriction while in use
- Uses 1,2 Hex Driver
- Package Contents: Cylinder + Cylinder Screw
- Tightening Torque: 20 Ncm

Pick-up Impression Coping



D	Ø4.8	Ø5.5
Type \ L	8.0	8.0
Hex	IPN 40508	IPN 50608
Non-Hex	IPN 40508N	IPN 50608N

- Create final impression of Conical Abutment on impression coping
- For use with pick-up type custom trays
- Package Contents: Impression Coping + Guide Pin

Conical Abutment Analog



L \ D	Ø4.8	Ø5.5
12	RCN 40412	RCN 50512

- Provides anchor point for Conical Abutment
- Package Contents: Analog

Cylinder Screw

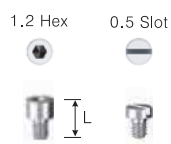

L \ Type	M1.4	M2.0
4.3	SHN 1403	SHN 2003
3.7	SSN 1403	SSN 2003

Ball Abutment

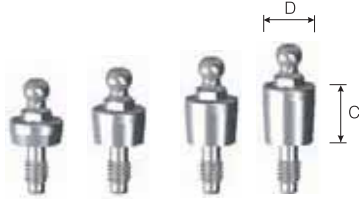

C \ D	Ø4.5
2	ABN 40502
3	ABN 40503
4	ABN 40504
5	ABN 40505

- Used in conjunction with ball type overdenture prosthetic fabrication
- O-Ring Types
  - Black: Laboratory type
  - Orange: Clinical type
- Uses O-Ring for ball retention
- Up to a 20° compensation
- Uses ball abutment driver
- Package Contents: Abutment + O-Ring
- Tightening Torque: 30 Ncm

Ball Abutment Analog



L \ D	Ø4.1
12	RBN 40412

- Provides anchor point for ball abutment on working model
- Package Contents: Analog

Dalbo Plus



	Regular
Code	DBPM 201

- Titanium housing with 2 stage construction
- Rated for up to 10,000 uses with minimum abrasion to the ball abutment and to the insert
- Simple and convenient retention
- Up to 20° in insertion angle flexibility
- Compatible with all DIO Implant systems

Retainer

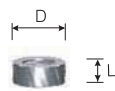

L \ D	Ø5.0
2	RT 0502

- Package Contents: Retainer + O-Ring

Ball Cap

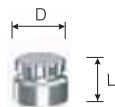

L \ D	Ø5.0
4	BC 5004

- Superior retention and removability
- Package Contents: Ball Cap + O-Ring

O-Ring



Type \ D	Ø4.5
Black	OR 0450B
Orange	OR 0450O

- Black: Laboratory used for fabrications with high retention
- Orange: For clinical use (over 6 Ncm)
- Package Contents: O-Ring (1 piece)

Locator



Cuff \ D	Narrow	Regular	Wide/T-Wide
0.73	LOC 8105	LOC 8681	LOC 8825
2	LOC 8106	LOC 8682	LOC 8826
3	LOC 8107	LOC 8683	LOC 8827
4	LOC 8108	LOC 8684	LOC 8828
5	LOC 8109	LOC 8696	LOC 8829

-Angled male adjustable even under extreme abutment angle (up to 40°)

-Lowest perpendicular angle

-Simple and precise denture mounting

-Wide variety of males; Great retention

# Master Surgical Kit

SM Implant System(SM-External)

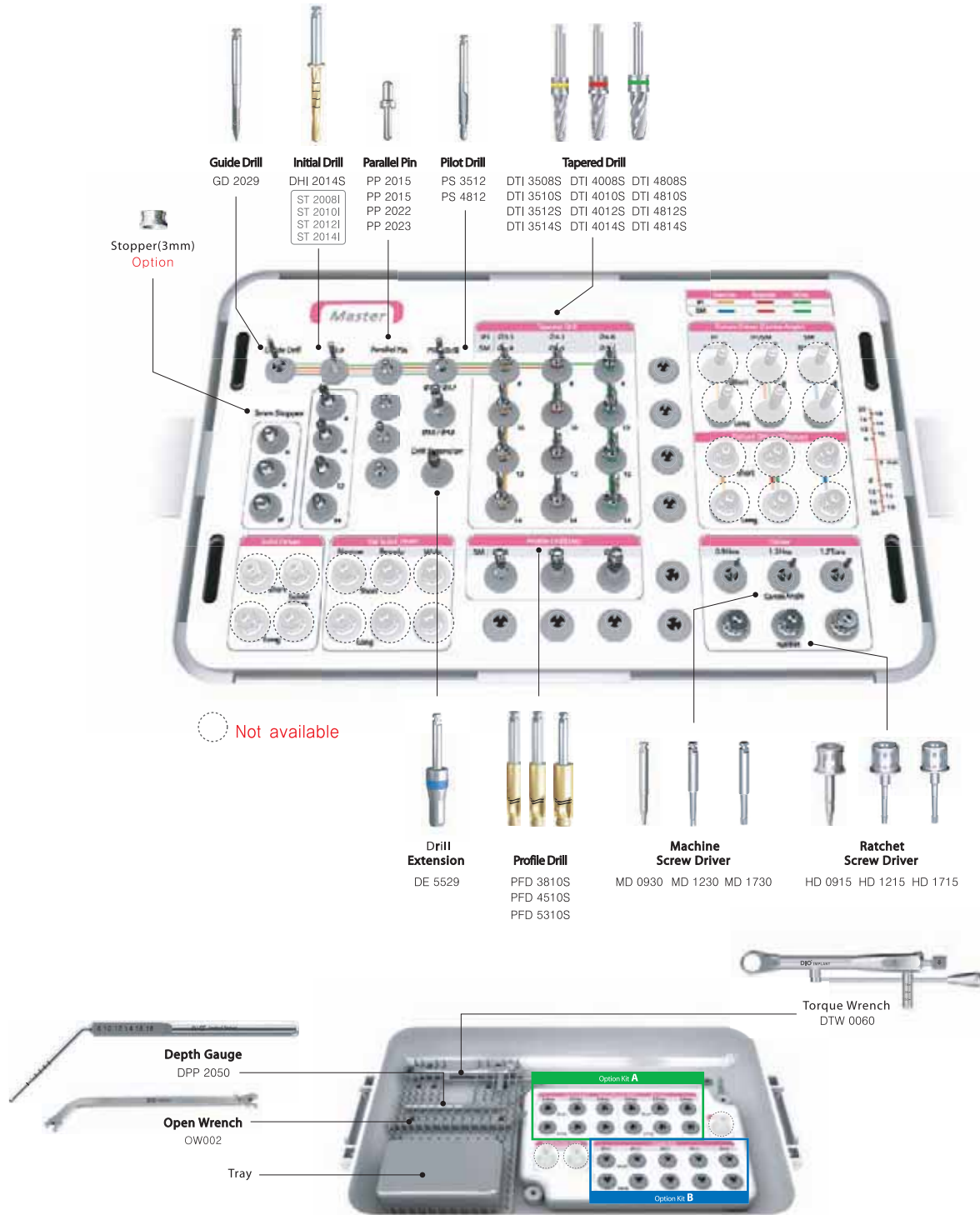

External System

## Master KIT Option

Option Kit A	Fixture Driver for Contra Angle	Fixture Driver for Ratchet Wrench
	HGC 3524 HGC 4024 HGC 5024 HGC 3530 HGC 4030 HGC 5030	HGW 3513 HGW 4013 HGW 5013 HGW 3521 HGW 4021 HGW 5021
Option Kit B *Choose No.1 (PSI) or No.2 (FSN)	Straight Drill 1. For PSI Implant(Internal)	Straight Drill 2. For FSN Implant(External)
	SDS 3010A SDS 3310A SDS 3510A SDS 4310A SDS 4810A SDS 3014A SDS 3314A SDS 3514A SDS 4314A SDS 4814A	SDS 3010B SDS 3310B SDS 3510B SDS 4310B SDS 4810B SDS 3015B SDS 3315B SDS 3515B SDS 4315B SDS 4815B
Option Kit C	Option Kit A + Option Kit B	

## Surgical Instruments

SM Implant System(SM-External)

### Guide Drill

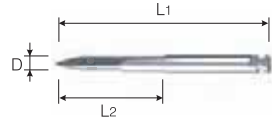

L1/L2	D	
		Ø2.0
25/11		GD 2025
29/15		GD 2029

- Used for drilling initial hole in bone tissue
- Bone density ascertainable during drilling

### Initial Drill

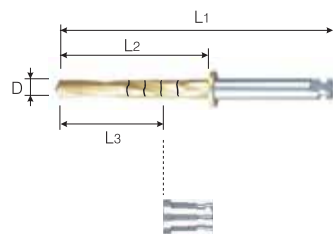

D	Ø2.0
L1	33.2
L2	18
Code	DHI 2014S
L3	Stopper
8	ST 2008I
10	ST 2010I
12	ST 2012I
14	ST 2014I

### Bone Planer

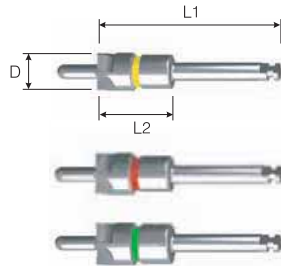

L1/L2	D	Ø4.95	Ø5.65	Ø5.9
24.5/10		BP 5010	BP 5710	BP 5910

- Creates a flat surface on bone
- Extracts desired bone with bone planer after initial drilling
- Handpiece speed: 400-600 rpm

### Tapered Drill

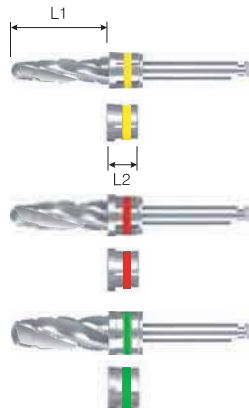

L1	Fixture Dia.	Ø3.5	Ø4.0	Ø4.8
8		DTI 3508S	DTI 4008S	DTI 4808S
10		DTI 3510S	DTI 4010S	DTI 4810S
12		DTI 3512S	DTI 4012S	DTI 4812S
14		DTI 3514S	DTI 4014S	DTI 4814S
L2		Stopper		
4		ST 3500I	ST 4000I	ST 4800I
3		ST 3501I	ST 4001I	ST 4801I

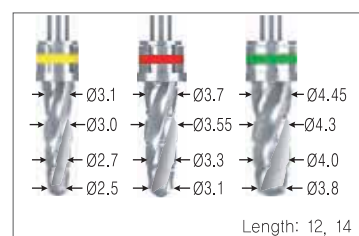
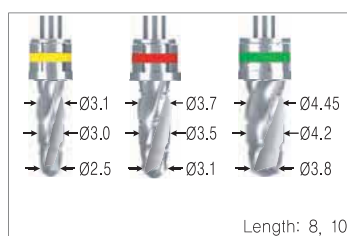

## Surgical Instruments

SM Implant System(SM-External)

### Drill Extension



L	Solid
29.7	DE 5529

- Provides extra length for drills used with handpieces
- Connects to the flat surface of the drill shank
- Resolves excess torque

### Lindemann Drill

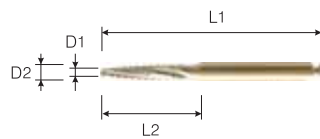

L1/L2	D1/D2	Ø1.4/Ø2.0
30/14		RMH 2014S

- Provides drill direction adjustment
- Useful in site preparation and ridge reduction in extractions

### Pilot Drill

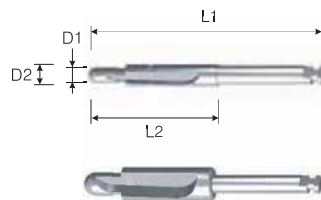

L1/L2	D1/D2	Ø2.0/Ø2.7
31/17		PS 3512
L1/L2	D1/D2	Ø3.0/Ø4.3
31/17		PS 4812

- Creates a path for drilling hole
- Creates accurate guide holes for the next step in surgical extraction

### Profile Drill

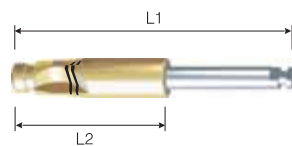

L1/L2	Fixture Dia.	Ø3.8	Ø4.5	Ø5.3
26.3/12.3		PFD 3805S	PFD 4505S	PFD 5305S
31.3/17.3		PFD 3810S	PFD 4510S	PFD 5310S
36.3/22.3		PFD 3815S	PFD 4515S	PFD 5315S

### Tap Drill

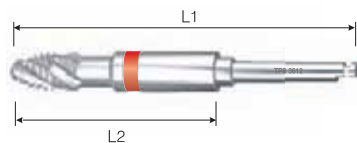

L1/L2	Fixture Dia.	Ø3.8	Ø4.1	Ø4.5	Ø5.0	Ø5.3
36.2/20.2		TPS 3812	TPS 4112	TPS 4512	TPS 5012	TPS 5312
41.2/25.2		TPS 3817	TPS 4117	TPS 4517	TPS 5017	TPS 5317

### Tap Adapter



L	5	TAPA 3011
	9.5	TAPA 3016

### Positioning Guide

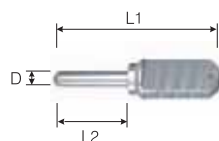

L1/L2	D	Ø2.0
22/10		PG 0050

- Marks space between fixtures
- Used after initial drilling

## Surgical Instruments

SM Implant System(SM-External)

Parallel Pin

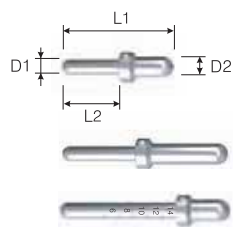

L1/L2	D1/D2	
		Ø2.0/Ø2.7
15/8		PP 2015
22/10		PP 2022
23/16		PP 2023

- Provides location and direction of site preparation
- Indicates the diameter of abutment and height of its collar
- Drill site depth survey
- Package Contents: Available as a part of a set or individual packaging

Depth Gauge



D	Ø2.0
Code	DPP 2050

Torque Wrench



Code	DTW 0060
------	----------

- Used in fixture implantation or screw repair
- Torque values (0, 15, 35, 50 Ncm) laser etched into the handle
- Convenient disassembly for easy cleaning

Open Wrench



Code	OW 002
------	--------

- Used in removing mounts from weak bone tissue
- 30° neck angle for maximum comfort and ease of use

Tissue Punch

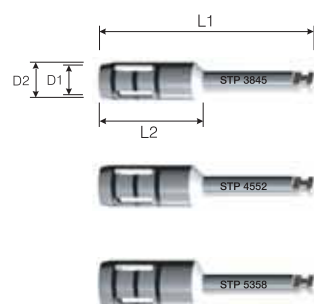

L1/L2	D1/D2	
		Ø3.8(Inner)/Ø4.5(Outer)
27/13		STP 3845

L1/L2	D1/D2	
		Ø4.5(Inner)/Ø5.2(Outer)
27/13		STP 4552

L1/L2	D1/D2	
		Ø5.3(Inner)/Ø5.8(Outer)
27/13		STP 5358

Machine Screw Driver

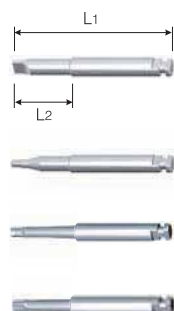

Type	L1/L2	Code
0.5 Slot	22/8	MD 0522
	30/16	MD 0530
0.9 Hex	22/8	MD 0922
	30/16	MD 0930
1.2 Hex	22/8	MD 1222
	30/16	MD 1230
1.7 Torx	22/8	MD 1722
	30/16	MD 1730



## Surgical Instruments

SM Implant System(SM-External)

### Ratchet Screw Driver



Type	L	Code
0.5 Slot	10	HD 0510
	15	HD 0515
0.9 Hex	10	HD 0910
	15	HD 0915
	20	HD 0920
1.2 Hex	5	HD 1205
	10	HD 1210
	15	HD 1215
1.7 Torx	20	HD 1220
	10	HD 1710
	15	HD 1715
	20	HD 1720

### Ball Abutment Driver



L	Code
6	HD 2406
12	HD 2412

### Fixture Driver for Contra Angle



Hex	2.4	2.7	3.4
L1/L2 \ D	Ø3.5	Ø4.1	Ø5.0
24/10	HGC 3524	HGC 4024	HGC 5024
30/16	HGC 3530	HGC 4030	HGC 5030
35/21	HGC 3535	HGC 4035	HGC 5035

### Fixture Driver for Ratchet Wrench



Hex	2.4	2.7	3.4
L \ D	Ø3.5	Ø4.1	Ø5.0
7	HGW 3513	HGW 4013	HGW 5013
15	HGW 3521	HGW 4021	HGW 5021
19	HGW 3525	HGW 4025	HGW 5025

## Surgical Instruments

SM Implant System(SM-External)

### Fixture Mount Driver



Hex	2.4	2.7	3.4
L \ D	Ø3.5	Ø4.1	Ø5.0
12	HMD 3512	HMD 4012	HMD 5012
18	HMD 3518	HMD 4018	HMD 5018
23	HMD 3523	HMD 4023	HMD 5023

### Ratchet Conical Abutment Screw Driver

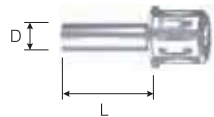

L \ D	2.0 Int. Hex	2.7 Int. Hex
12	HD 2012	HD 2712

### Path Pin



L \ D	Ø3.5	Ø4.0	Ø5.1
9	PPE 3509	PPE 4009	PPE 5009

### Trepine Drill

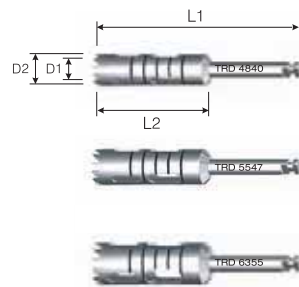

L1/L2 \ D1/D2	Ø4.0(Inner)/Ø4.8(Outer)
32/18	TRD 4840

L1/L2 \ D1/D2	Ø4.7(Inner)/Ø5.5(Outer)
32/18	TRD 5547

L1/L2 \ D1/D2	Ø5.5(Inner)/Ø6.3(Outer)
32/18	TRD 6355

### Ratchet Wrench



Code	DRW 050
------	---------

## Site Preparation

### Fixture Driver

Instructions for proper fixture driver use  
Remove driver from fixture only after adhesion

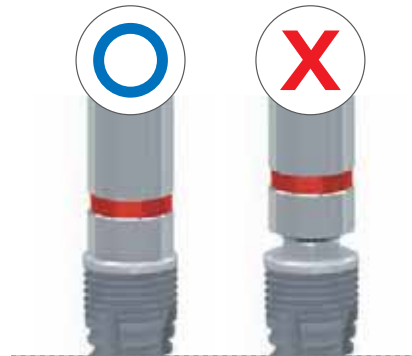

## Site Preparation

SM-External Fixture / Ø4.5mm(Length: 12mm)

Guide drill    Ø2.0 Initial drill    Depth gauge    Parallel pin    Pilot drill    Tapered drill    Profile drill    SM-Ext. Fixture

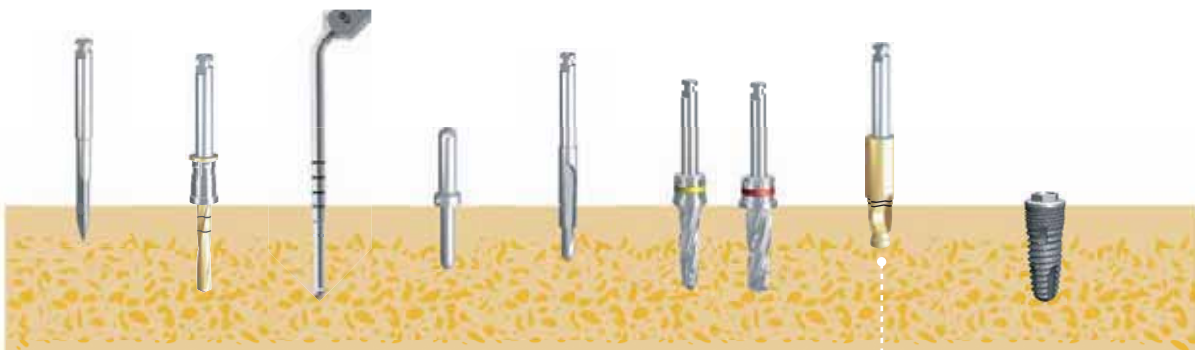

### Profile drill

Used to shape top of fixture (Straight & Taper shape)

Insertion depth: Drilling depth is determined by bone tissue.  
Drills up to B depth in case of D1/D2 bone.  
Tap drill is recommended in cases where the D1 bone tissue is resistant.  
Drills up to A depth in case of D2/D3 bone.  
Profile drill is not recommended in cases where the D4 bone tissue is weak.

This drill is designed to prevent excess torque  
Implant depth is adjustable

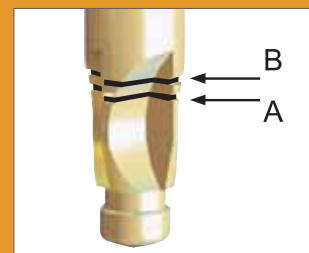

# FSN Surgical Kit

## External Implant System(FSN)

External System

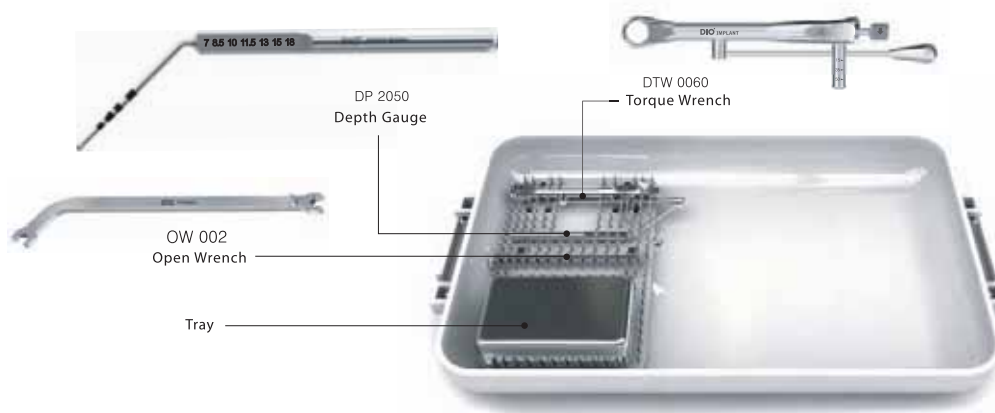
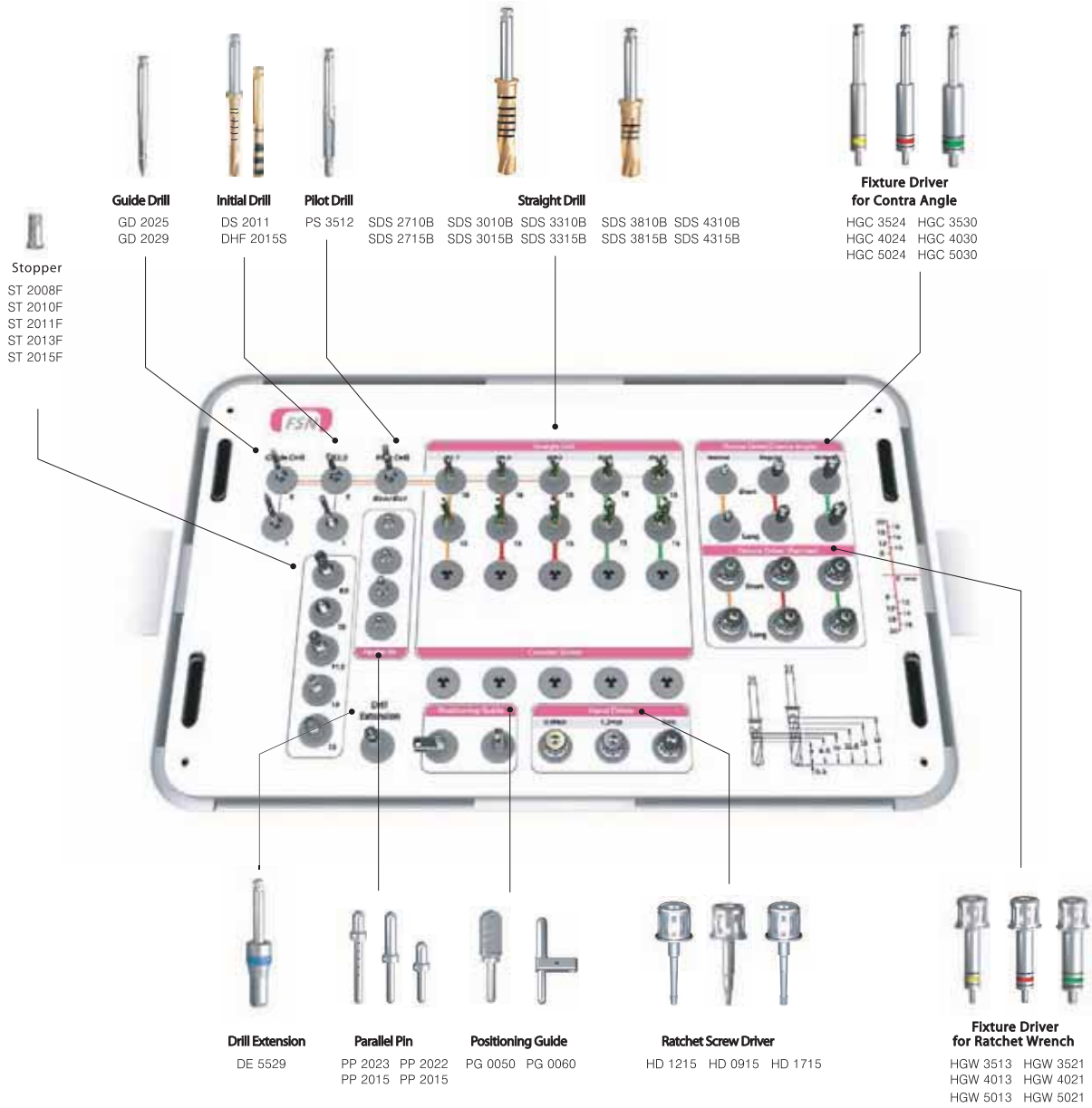

# FTN Surgical Kit

## External Implant System(FTN)

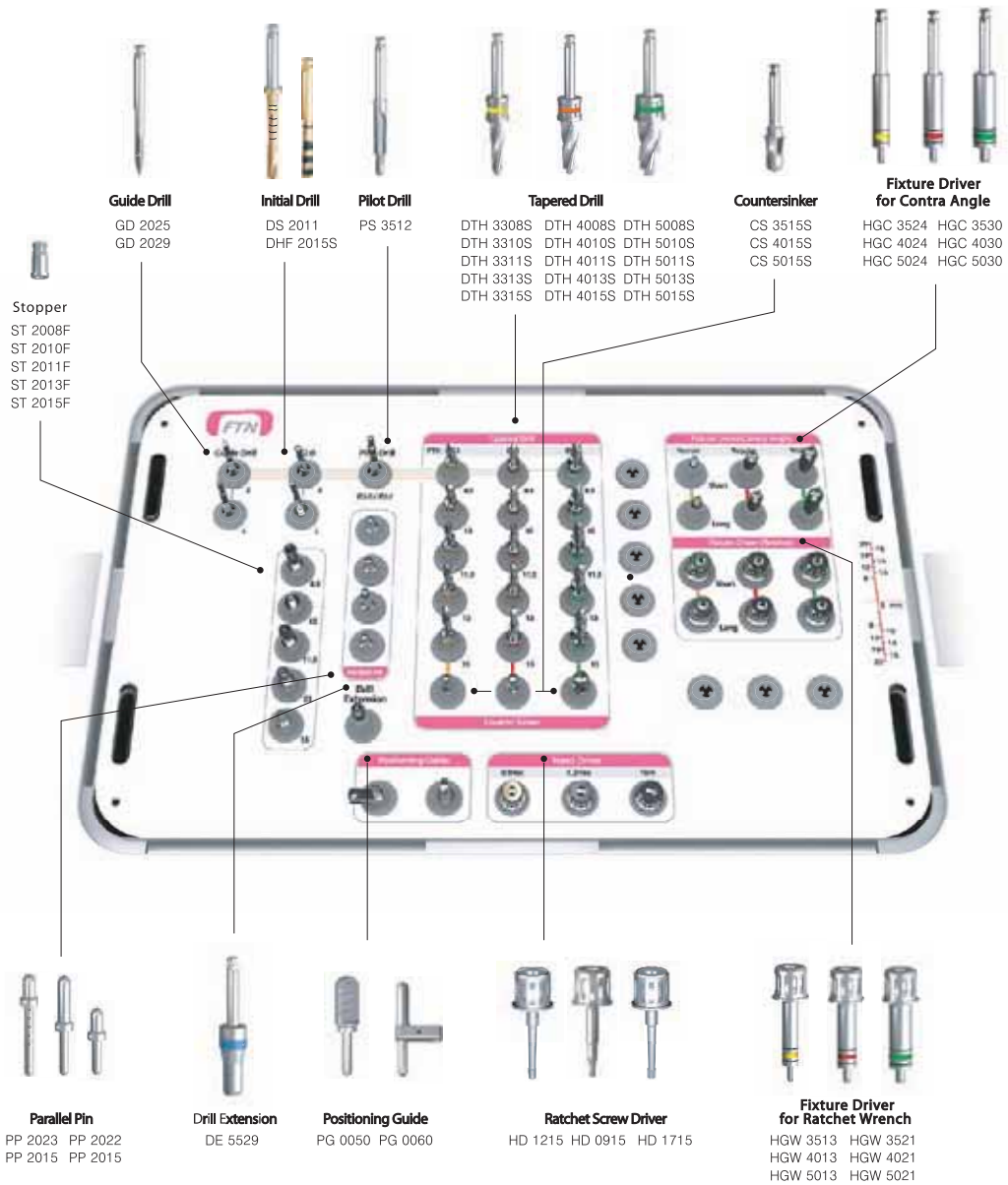

External System

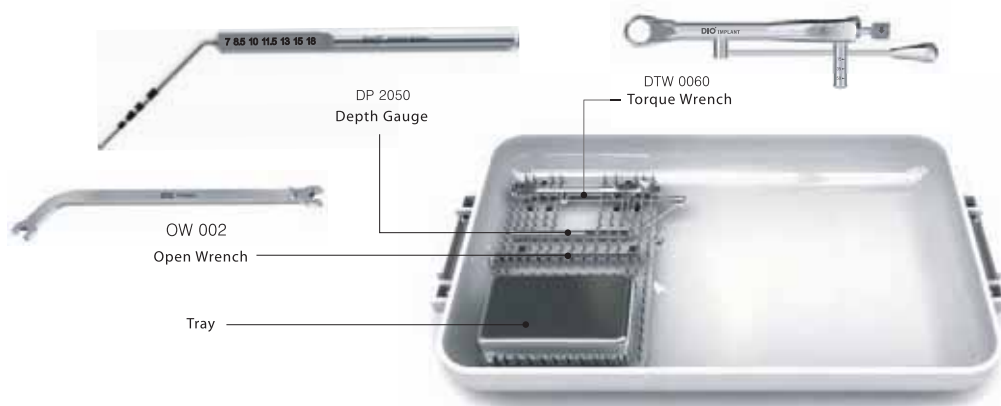

## Surgical Instruments

External Implant System(FSN/FTN)

### Guide Drill

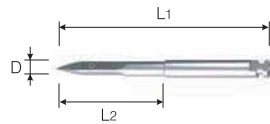

L1/L2	D	Code
25/11	Ø2.0	GD 2025
29/15	Ø2.0	GD 2029

-Used for drilling initial hole in bone tissue  
-Bone density ascertainable during drilling

### Initial Drill

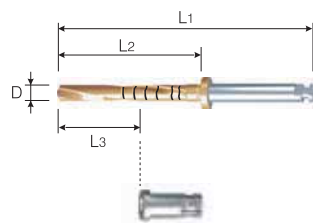

D	Code
Ø2.0	DHF 2015S
L1	34
L2	19
L3	Stopper
8.5	ST 2008F
10	ST 2010F
11.5	ST 2011F
13	ST 2013F
15	ST 2015F

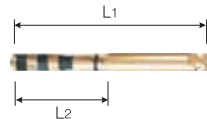

L1/L2	D	Code
27.5/13	Ø2.0	DS 2011

### Straight Drill FSN

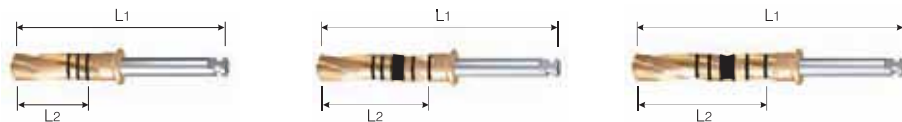

L1/L2	D	Ø2.7	Ø3.0	Ø3.3	Ø3.5	Ø3.8	Ø4.3	Ø4.8
24/10		SDS 2710B	SDS 3010B	SDS 3310B	SDS 3510B	SDS 3810B	SDS 4310B	SDS 4810B
29/15		SDS 2715B	SDS 3015B	SDS 3315B	SDS 3515B	SDS 3815B	SDS 4315B	SDS 4815B
32/18		SDS 2718B	SDS 3018B	SDS 3318B	SDS 3518B	SDS 3818B	SDS 4318B	SDS 4818B

### Tapered Drill FTN



L1	Code		
8.7	DTH 3308S	DTH 4008S	DTH 5008S
10.2	DTH 3310S	DTH 4010S	DTH 5010S
11.7	DTH 3311S	DTH 4011S	DTH 5011S
13.2	DTH 3313S	DTH 4013S	DTH 5013S
15.2	DTH 3315S	DTH 4015S	DTH 5015S
L2	Stopper		
4	ST 3300F	ST 4000F	ST 5000F

## Surgical Instruments

External Implant System(FSN/FTN)

### Drill Extension



L	Code
29	DE 5529

- Provides extra length for drills used with handpieces
- Connects to the flat surface of the drill shank
- Resolves excess torque

### Pilot Drill

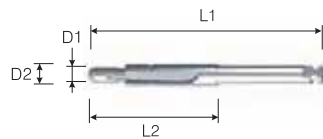

L1/L2	D1/D2	Code
		Ø2.0/Ø2.7
31/17		PS 3512

- Creates a path for drilling hole
- Creates accurate guide holes for the next step in surgical extraction

### Countersinker



L1/L2	Code		
24/10	CS 3510S	CS 4010S	CS 5010S
29/15	CS 3515S	CS 4015S	CS 5015S
34/20	CS 3520S	CS 4020S	CS 5020S

### Lindemann Drill

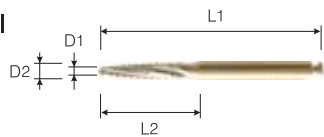

L1/L2	D1/D2	Code
		Ø1.4/Ø2.0
30/14		RMH 2014S

- Provides drill direction adjustment
- Useful in site preparation and ridge reduction in extractions

### Positioning Guide

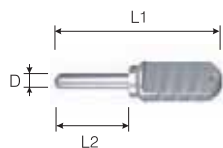

L1/L2	D	Code
	Ø2.0	
22/10		PG 0050



L	D	Code
	Ø2.0	
7		PG 0060

- Marks space between fixtures
- Used after initial drilling

### Parallel Pin

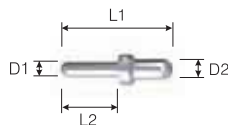

L1/L2	D1/D2	Code
		Ø2.0/Ø2.7
15/8		PP 2015
22/10		PP 2022
23/16		PP 2023

- Provides location and direction of site preparation
- Indicates the diameter of abutment and height of its collar
- Drill site depth survey
- Package Contents: Available as a part of a set or individual packaging

## Surgical Instruments

External Implant System(FSN/FTN)

### Path Pin



L \ D	Ø3.5	Ø4.0	Ø5.1
9	PPE 3509	PPE 4009	PPE 5009

### Depth Gauge

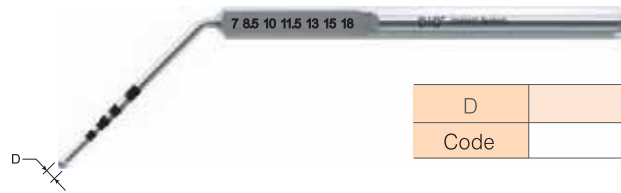

D	Ø2.0
Code	DP 2050

### Torque Wrench



Code	DTW 0060
------	----------

- Used in fixture implantation or screw repair
- Torque values (0, 15, 35, 50 Ncm) laser etched into the handle
- Convenient disassembly for easy cleaning

### Open Wrench



Code	OW 002
------	--------

- Used in removing mounts from weak bone tissue
- 30° neck angle for maximum comfort and ease of use

### Fixture Driver for Contra Angle



Hex	2.4	2.7	3.4
L1/L2 \ D	Ø3.5	Ø4.1	Ø5.0
24/10	HGC 3524	HGC 4024	HGC 5024
30/16	HGC 3530	HGC 4030	HGC 5030
35/21	HGC 3535	HGC 4035	HGC 5035



## Surgical Instruments

External Implant System(FSN/FTN)

### Fixture Driver for Ratchet Wrench



Hex	2.4	2.7	3.4
L \ D	Ø3.5	Ø4.1	Ø5.0
7	HGW 3513	HGW 4013	HGW 5013
15	HGW 3521	HGW 4021	HGW 5021
19	HGW 3525	HGW 4025	HGW 5025

### Fixture Mount Driver



Hex	2.4	2.7	3.4
L \ D	Ø3.5	Ø4.1	Ø5.0
12	HMD 3512	HMD 4012	HMD 5012
18	HMD 3518	HMD 4018	HMD 5018
23	HMD 3523	HMD 4023	HMD 5023

### Ratchet Screw Driver



L \ Type	0.5 Slot	0.9 Hex	1.2 Hex	1.7 Torx
5	-	-	HD 1205	-
10	HD 0510	HD 0910	HD 1210	HD 1710
15	HD 0515	HD 0915	HD 1215	HD 1715
20	-	HD 0920	HD 1220	HD 1720

## Surgical Instruments

External Implant System(FSN/FTN)

### Machine Screw Driver

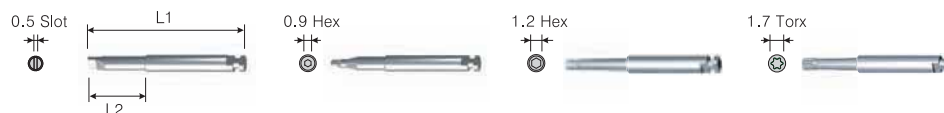

L1/L2	Type	0.5 Slot	0.9 Hex	1.2 Hex	1.7 Torx
22/8		MD 0522	MD 0922	MD 1222	MD 1722
30/16		MD 0530	MD 0930	MD 1230	MD 1730

### Conical Abutment Screw Driver



L	D	2.0 Int. Hex	2.7 Int. Hex
12		HD 2012	HD 2712

### Ball Abutment Driver



L	Type	Int. 2.4 Hex
6		HD 2406
12		HD 2412

### Trephine Drill

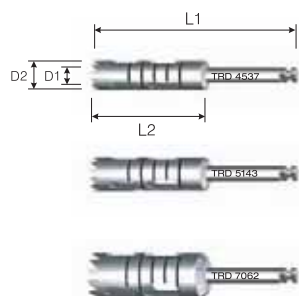

L1/L2	D1/D2	Ø4.0(Inner)/Ø4.8(Outer)
32/18		TRD 4840

L1/L2	D1/D2	Ø4.7(Inner)/Ø5.5(Outer)
32/18		TRD 5143

L1/L2	D1/D2	Ø5.5(Inner)/Ø6.3(Outer)
32/18		TRD 7062

### Ratchet Wrench



Code	DRW 050
------	---------

## Site Preparation

### FSN Fixture

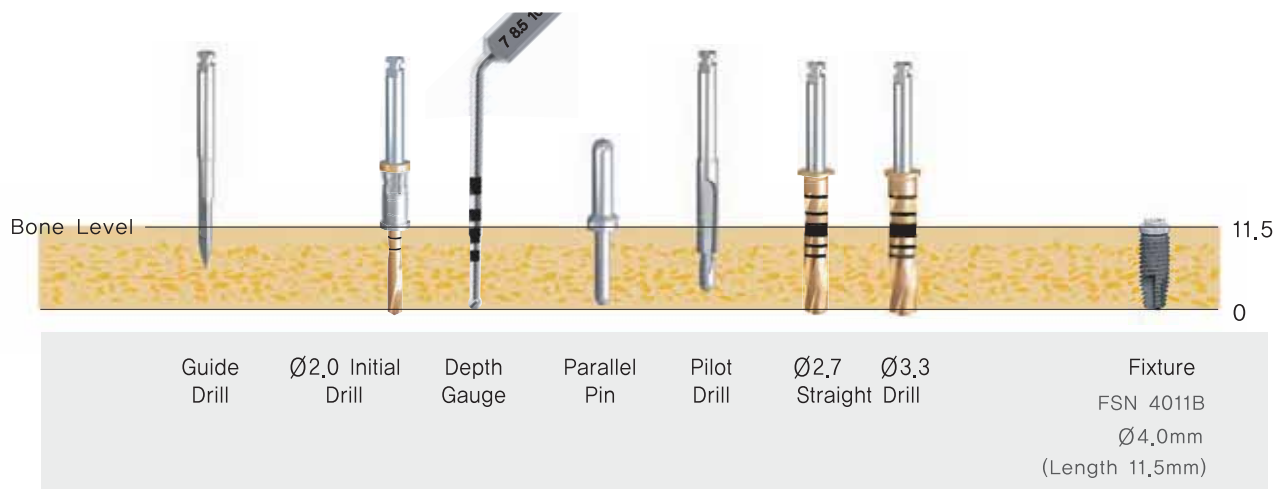

External System

### FTN Fixture

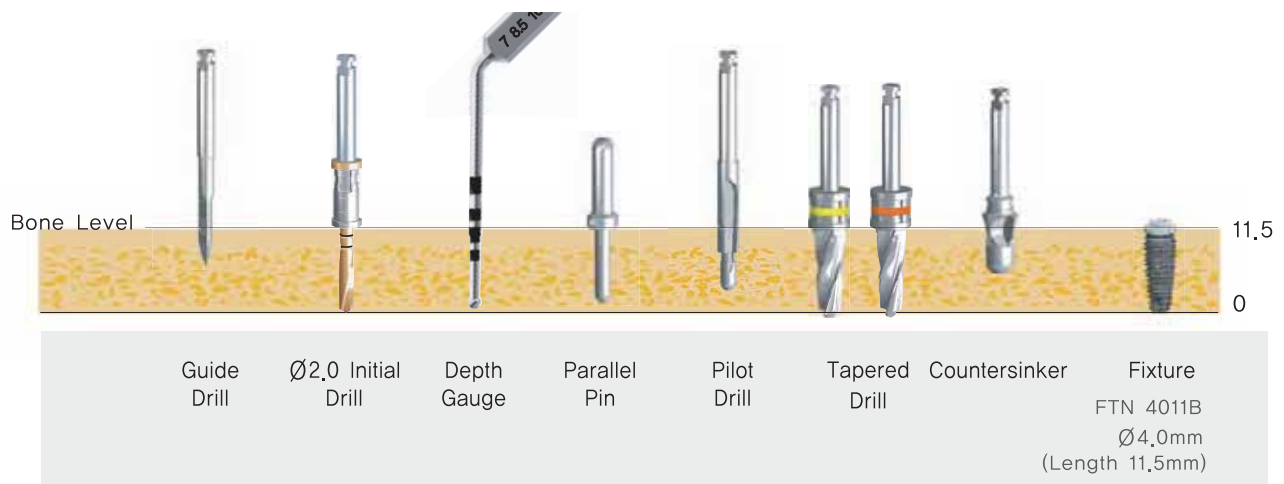



# ProTem/Secure

Protem/Secure Implant System

Post / Ball Type



System Flowchart .....	136
Post Type .....	138
ProTem/Secure-H(Post) .....	139
Ball Type .....	140
ProTem/Secure-H(Ball) .....	140
Surgical Kit	
ProTem/Secure Surgical Kit / Site Preparation .....	142
Surgical Instruments .....	142

**DIO IMPLANT SYSTEM**

[www.dio.co.kr](http://www.dio.co.kr)

## ProTem/Secure(Post) System Flowchart

---

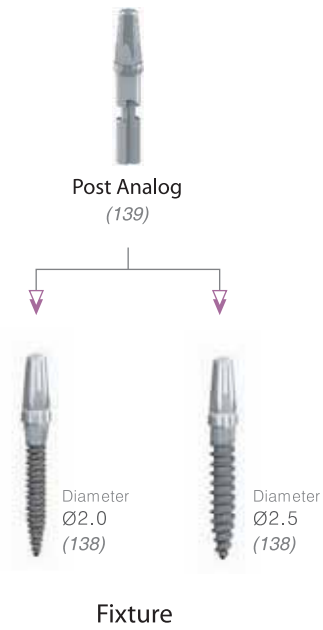

## ProTem/Secure(Ball) System Flowchart

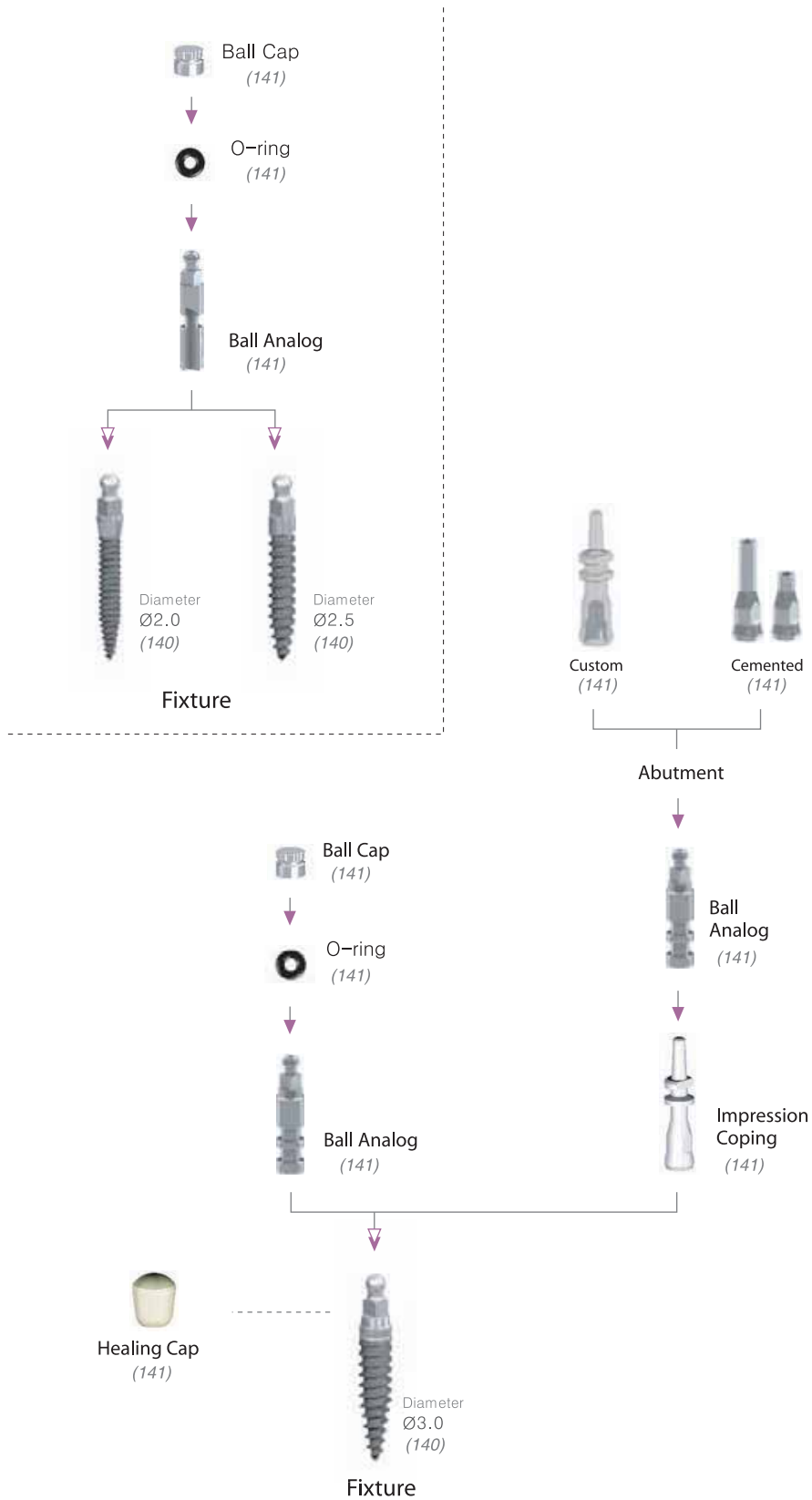

## ProTem/Secure(Post) Fixture

- › Suitable for narrow spaces on the upper mandible
- › Single body Fixture and Abutment designed to withhold the stress of mastication
- › Highly bio-compatible RBM/Brushite(CaP) surface
- › Optimal abutment size and form to ensure successful implantation
- › Self-Tapping body design for secure initial entry and firm gripping power

\*Secure Fixture is exported to the USA and is an FDA approved product



Length: 10 12 14

Diameter	Ø2.0	
Pitch	0.6	
L \ C	2	4
10	MFP 20210	MFP 20410
12	MFP 20212	MFP 20412
14	MFP 20214	MFP 20414

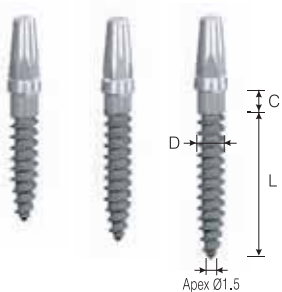

Length: 10 12 14

Diameter	Ø2.5	
Pitch	1	
L \ C	2	4
10	MFP 25210	MFP 25410
12	MFP 25212	MFP 25412
14	MFP 25214	MFP 25414

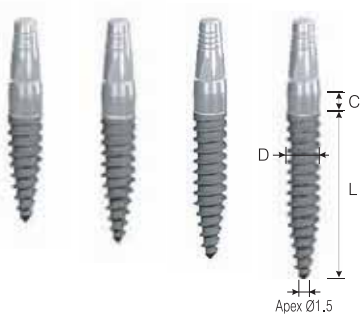

Length: 10 12 14 16

Diameter	Ø3.0	
Pitch	1	
L \ C	2	4
10	MFP 30210A	MFP 30410A
12	MFP 30212A	MFP 30412A
14	MFP 30214A	MFP 30414A
16	MFP 30216A	MFP 30416A



## ProTem/Secure(Post) Fixture

Brushite(CaP)  
Coated  
"ProTem/Secure-H"

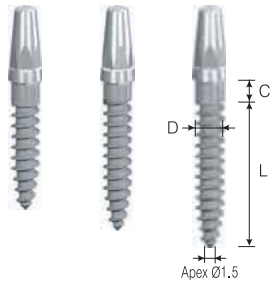

Length: 10      12      14

Diameter	Ø2.5	
Pitch	1	
L \ C	2	4
10	MFP 25210H	MFP 25410H
12	MFP 25212H	MFP 25412H
14	MFP 25214H	MFP 25414H



Length: 10      12      14      16

Diameter	Ø3.0	
Pitch	1	
L \ C	2	4
10	MFP 30210AH	MFP 30410AH
12	MFP 30212AH	MFP 30412AH
14	MFP 30214AH	MFP 30414AH
16	MFP 30216AH	MFP 30416AH

ProTem/Secure System

### Post Analog



Ø2.0 / Ø2.5

Ø3.0

L \ Fixture Dia.	Ø2.0 / Ø2.5	Ø3.0
10	MAP 3010	MAP 3017

-Provides anchor point for fabricating ProTem/Secure Implant Post  
-Package Contents: Analog

## ProTem/Secure(Ball) Fixture



Diameter	Ø2.0	
Pitch	0.6	
L \ C	2	4
10	MFB 20210	MFB 20410
12	MFB 20212	MFB 20412
14	MFB 20214	MFB 20414

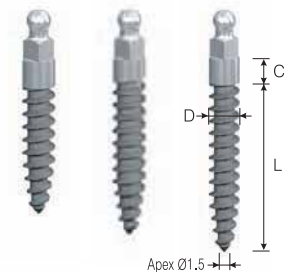

Diameter	Ø2.5	
Pitch	1	
L \ C	2	4
10	MFB 25210	MFB 25410
12	MFB 25212	MFB 25412
14	MFB 25214	MFB 25414

Length: 10 12 14

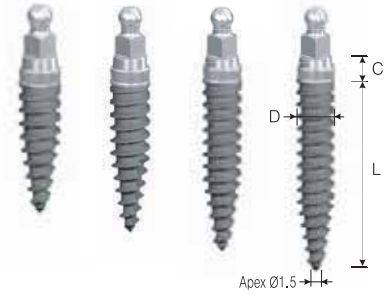

Diameter	Ø3.0	
Pitch	1	
L \ C	2	4
10	MFB 30210A	MFB 30410A
12	MFB 30212A	MFB 30412A
14	MFB 30214A	MFB 30414A
16	MFB 30216A	MFB 30416A

Length: 10 12 14 16

ProTem/Secure System

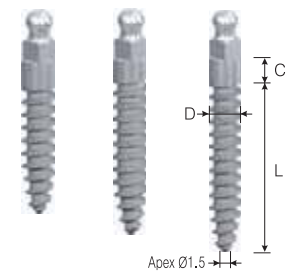
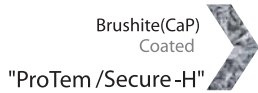

Diameter	Ø2.5	
Pitch	1	
L \ C	2	4
10	MFB 25210H	MFB 25410H
12	MFB 25212H	MFB 25412H
14	MFB 25214H	MFB 25414H

Length: 10 12 14

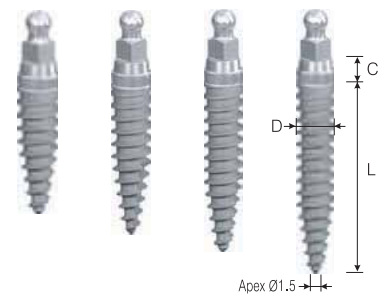

Diameter	Ø3.0	
Pitch	1	
L \ C	2	4
10	MFB 30210AH	MFB 30410AH
12	MFB 30212AH	MFB 30412AH
14	MFB 30214AH	MFB 30414AH
16	MFB 30216AH	MFB 30416AH

Length: 10 12 14 16

Restorative Products  
**ProTem/Secure(Ball)**

- › Used in creating an immediate temporary system for removable prosthetics
- › Peek system healing cap and analog provides simple and convenient temporary prosthetic fabrication
- › Body designed for secure initial entry and firm gripping power
- › Optimal self-tapping thread design

Healing Cap

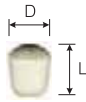

L	D	
		Ø5.0
6		MHC 5006
8		MHC 5008

\*For use with Ø3,0

Ball Cap

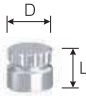

L	D	
		Ø3.8
3.4		MBC 3803

O-ring



L	D	
		Ø3.4
1		OR 3401

Cemented Abutment



Length: 8      12

L	D	
		Ø3.5
8		MCB 3508
12		MCB 3512

\*For use with Ø3,0

Custom Abutment

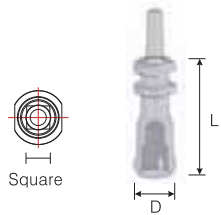

Length	Square	D	
			Ø4.0
11	1.67		MCA 4011

\*For use with Ø3,0

Impression Coping

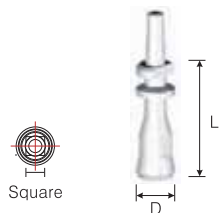

Length	Square	D	
			Ø3.5
11	1.67		MIC 3511

\*For use with Ø3,0

Ball Analog



Ø2.0 / Ø2.5      Ø3.0

L	Fixture Dia.		
		Ø2.0 / Ø2.5	Ø3.0
10		MAB 2510	MAB3014

## ProTem/Secure Surgical Kit

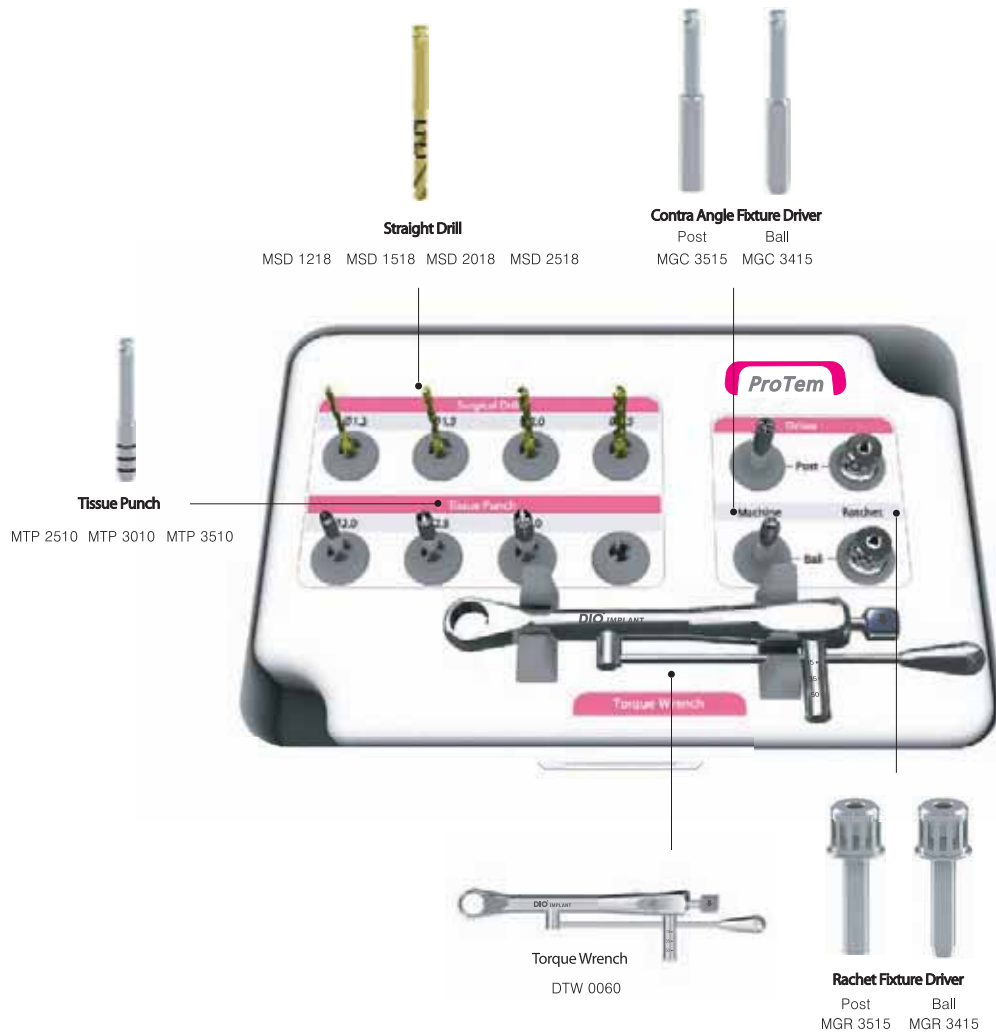

## Site Preparation

Post type / Ø3.0mm(Length: 12mm)

Ball type / Ø3.0mm(Length: 12mm)



No.	Fixture Diameter	Pitch	Dense Bone		Medium Bone		Poor Bone	
			Drill(Ø)	Depth(mm)	Drill(Ø)	Depth(mm)	Drill(Ø)	Depth(mm)
1	Ø2.0	0.6	1.2	1/2~3/4	1.2	Cortical~1/2	-	-
2	Ø2.5	1	2.0	1/2~3/4	1.5	1/2	1.5	Cortical
3	Ø3.0	1	2.5	3/4~Full	2.0~2.5	1/2~Full	2.0~2.5	1/3~1/2

### Straight Drill



L \ D	Ø1.2	Ø1.5	Ø2.0	Ø2.5
12	MSD 1212	MSD 1512	MSD 2012	MSD 2512
18	MSD 1218	MSD 1518	MSD 2018	MSD 2518

–Compatible with Post type and Ball type

### Tissue Punch



L \ D1/D2	Ø2.0/Ø2.5	Ø2.5/Ø3.0	Ø3.0/Ø3.5
10	MTP 2510	MTP 3010	MTP 3510

–D1: Inner diameter; D2: Outer diameter  
–Compatible with Post type and Ball type

### Contra Angle Fixture Driver

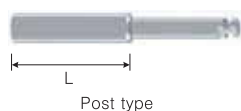

Type	Post type	Ball type
L \ D	Ø3.5	Ø3.4
10	MGC 3510	MGC 3410
15	MGC 3515	MGC 3415
20	MGC 3520	MGC 3420

### Ratchet Fixture Driver

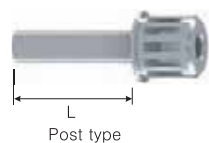

Type	Post type	Ball type
L \ D	Ø3.5	Ø3.4
10	MGR 3510	MGR 3410
15	MGR 3515	MGR 3415
20	MGR 3520	MGR 3420

### Trephine Drill



L \ D	D1 (Inner): Ø2.2 D2 (Outer): Ø3.0
18	TRD 3022
L \ D	D1 (Inner): Ø2.7 D2 (Outer): Ø3.5
18	TRD 3527
L \ D	D1 (Inner): Ø3.2 D2 (Outer): Ø4.0
18	TRD 4032

### Torque Wrench



Code	DTW 0060
------	----------

–Used in fixture implantation or screw repair  
–Torque values (0, 15, 35, 50 Ncm) laser etched into the handle  
–Convenient disassembly for easy cleaning

# Surgical Kits

Bone Expander Kit .....	145
Sinus Lift Kit .....	146
Osteotome Kit .....	147
Prosthetic Kit .....	148

**DIO IMPLANT SYSTEM**







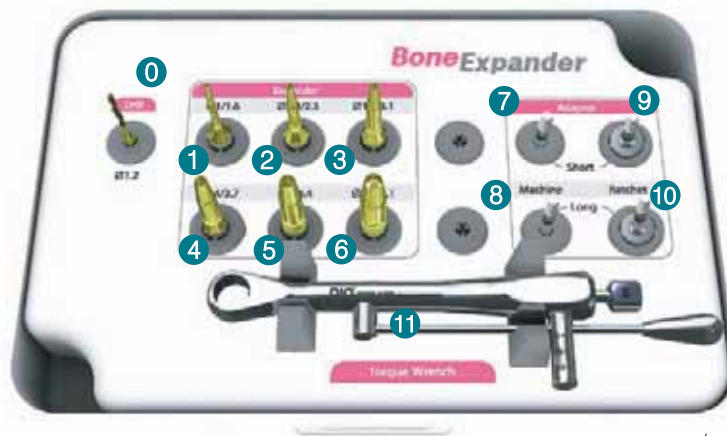
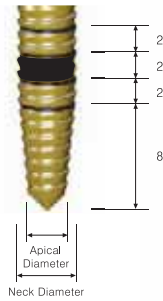





[www.dio.co.kr](http://www.dio.co.kr)

## Bone Expander Kit

The bone expander kit gradually and gently expands bone tissue to access osteotomy site without bone loss, the kit increase initial safety by keeping the bone density stable,



(mm)

Description	Code	Diameter Apical / Neck	Length	Color Code
 1.2mm Initial Drill	MSD 1218	1.2	16	
 1.0/1.6mm Bone Expander	BEP 1716	1.0 / 1.6	17	Yellow
 1.3/2.3mm Bone Expander	BEP 1723	1.3 / 2.3	17	Yellow
 1.7/3.1mm Bone Expander	BEP 1731	1.7 / 3.1	17	Yellow
 2.4/3.7mm Bone Expander	BEP 1737	2.4 / 3.7	17	Red
 3.0/4.4mm Bone Expander	BEP 1744	3.0 / 4.4	17	Green
 3.5/5.1mm Bone Expander	BEP 1751	3.5 / 5.1	17	
 Driver(short) For Contra Angle	MHDC 2520			
 Driver(long)	MHDC 2525			
 Driver(short) For Ratchet Wrench	MHDR 2513			
 Driver(long)	MHDR 2518			
 Ratchet Wrench	DTW 0060			
 Open Wrench	OW 002			

## Sinus Lift Kit

Custom designed kit comprised of 6 tools used in sinus procedures

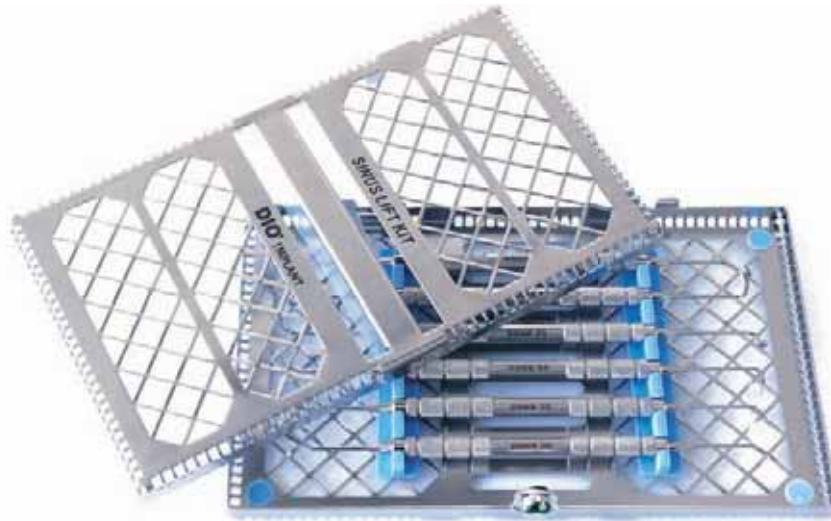













Sinus Elevator & Membrane Lift Tips		Code	Description
			DSNK 01 Membrane Detach Elevator
			DSNK 02 Membrane Elevator
			DSNK 03 Membrane Elevator
			DSNK 04 Membrane Elevator
			DSNK 05 Membrane Elevator
			DSNK 06 Bone Graft Packer



## Osteotome Kit



Diameter(L)	Image	Code	Application
0 		OSE 2228	SM/ IFI/ FTN Initial Drill
1 		OSL 2028	Sinus Elevation
2 		OSL 2130	FTN 33xxB Compaction
3 		OSL 2133	SFN 38xx/ IFI 35xxPM Compaction
4 		OSL 3039	SFR 45xx/ IFI 40xxM Compaction
5 		OSL 3546	SFW 53xx/ IFI 48xxM/ FTN 50xxB Compaction

# Prosthetic Kit



## 0 Octa Abutment Driver



Type	L	Code
3.0 Octa	12	HD 3012

## 1 Ball Abutment Driver



L	Code
12	HD 2412

## 2 Internal Solid Abutment Driver



L	Abutment Dia.	
	Ø3.5	Ø4.3
6	HD 3506	HD 4306
12	HD 3512	HD 4312

3 Machine Screw Driver

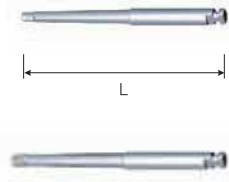

Type	L	Code
1.2 Hex	30	MD 1230
1.7 Torx	30	MD 1730

4 Ratchet Screw Driver

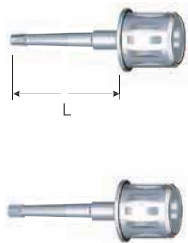

Type	L	Code
1.2 Hex	15	HD 1215
1.7 Torx	15	HD 1715

5 SM Solid Abutment Driver



L	Abutment Dia.		
	Ø3.9	Ø4.8	Ø5.8
6	HDS 3906	HDS 4806	HDS 5806
12	HDS 3912	HDS 4812	HDS 5812

6 Torque Wrench



Code	DTW 0060
------	----------

Gingival Depth Gauge



Code	GDG 3135
------	----------





# Dental Products

Implant Surgical Devices .....	152
Handpiece(Low speed handpiece) .....	154
Handpiece(High speed handpiece) .....	155
Dental Materials .....	156
Sterilizers .....	156
Membrane .....	156
Bone Material .....	157

**DIO IMPLANT SYSTEM**

[www.dio.co.kr](http://www.dio.co.kr)

## Implant Surgical Devices

### Light Therapy OsseoPulse



#### ■ Characteristics

Initial Stability maintaining and improving

- 2 weeks after implant insertion is Resorptive Phase, That is the time that the bone is resorbed.

Per multi center clinical trial, OsseoPulse treatment maintains and improves initial stability.

Osseointegration facilitation

- In-vitro and In-vivo test results show 58% reduction in osseointegration time, facilitating surgical area tissue healing
- LED treatment facilitating tissue healing was proven by many scientific papers.

Implant surgery period shortening, more patient turnover

- Fast osseointegration shortens the 2nd surgery period and increases patient turnover.

High end treatment

- High end service for patients for expensive implant surgery

Implant marketing

- Showing off OsseoPulse-treated patients in the clinic can promote implant-specialty image of the clinic.

#### ■ Osseopulse principle



Implant insertion  
Mitochondria cytochrome oxidase is a respiratory organ of the cell



LED radiation  
Radiates Osseopulse to the surgery area.

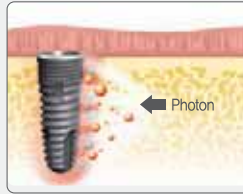

LED function 1  
MCO absorbs photon from Osseopulse  
MCO(Mitochondria cytochrome oxidase is a photon acceptor

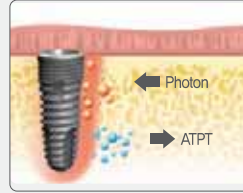

LED function 2  
By absorbing photon, it maximizes ATP (Adenosine triphosphate) production.



LED function 3  
Increased ATP production increases metabolism, and facilitates osseointegration and wound healing

■ Manufactured by | BIOLUX(Canada)

■ Korean Distribution | DIO Implant

Implant Mobility Measurement Device  
**Periotest M**



- Periotest applications
  - Fixture Stability Measurement
  - Abutment Stability Measurement
  - Periodontium Condition Measurement
  - Occlusal Load Measurement
  - \*Confirms the success/failure of prosthesis
- Features
  - Hassle free wireless tooth mobility measuring device.
  - No additional probes or adaptors needed.
  - One touch convenience.
  - Shows initial stability values after implant insertion.
  - Check the occlusal load of natural teeth as well as implants.
- Product Specifications
  - Size 197mm x 70mm x 105mm
  - Weight main unit (150g): Recharger (80g)
  - Voltage 100–240V: AC 50/60Hz: 12V DC
  - Current 800mA (max)
- Manufactured by | Medizintechnik Gulden (Germany)
- Korean Distribution | DIO Implant

Surgical Engine  
**DIO-Anthogyr**



- Features
  - Convenient touch–screen operation.
  - Real–time RPM and torque values displayed during surgery.
  - Calibration module between contra–angle and motor.
  - 3 protocol (4 step) changing and saving function.
    - ex) Protocol 1: Hard Bone
    - Protocol 2: Soft Bone
    - Protocol 3: Medium Bone
  - Flow pump – 5 step adjustment, 0 ~ 60ml/min
  - All functions controlled by foot pedal during surgery.
- Product Specifications
  - Voltage 220V, 50/60Hz
  - Speed 500–40,000rpm
  - Torque Range 7–55Ncm (up to 80Ncm with Mont Blanc handpiece)
  - Size 250mm x 205mm x 130mm
  - Contents: Engine unit, foot pedal, micromotor, handpiece, irrigation tube
- Manufactured by | Anthogyr (France)
- Korean Distribution | DIO Implant

Contra-angle  
**Montblanc Contra-angle**



- Features
  - Excellent grip and power of up to 80 N.cm
  - Head and gear can be disassembled from the body, easy component replacement, and excellent durability
- Manufactured by | Anthogyr (France)
- Korean Distribution | DIO Implant

## Handpiece(Low speed handpiece)

### External irrigation

#### LSCE



Type	Low Speed Curved Handpiece -Non Fiber Optic
Bearing	Steel Ball
Burr Install	Push Type
Cooling System	Single Spray/ External Cooling System
Weight	46g
Head Size	H: 14.1 (mm) Ø: 9.8 (mm)
Transmission	1:1
Max Speed	40,000rpm

#### LSSE



Type	Low Speed Straight Handpiece -Non Fiber Optic
Bearing	Steel Ball
Burr Install	Switch to disconnect
Cooling System	Single Spray/ External Cooling System
Weight	62.3g
Transmission	1:1
Max Speed	40,000rpm

#### AME



Type	Low Speed Air Motor
Weight	79.3g
Cooling System	External System/ Adjustable Water Volume
Max Speed	15,000rpm ~ 18,000rpm
Air pressure	2.5~2.8kg/cm <sup>2</sup>

■ Korean Distribution | DIO Implant

### Internal irrigation

#### LSCI



Type	Low Speed Curved Handpiece -Non Fiber Optic
Bearing	Steel Ball
Burr Install	Push Type
Cooling system	Single Spray/Internal Cooling System
Weight	84.2g
Head Size	H: 14.1 (mm) Ø: 9.8 (mm)
Transmission	1:1

#### LSSI



Type	Low Speed Straight-Angle -Non Fiber Optic
Bearing	Steel Ball
Burr Install	Switch to disconnect
Cooling system	Single Spray/ Internal Cooling System
Weight	90.2g
Transmission	1:1

#### AMI



Type	Low Speed Air Motor
Weight	73.3g
Cooling System	Internal System/ Adjustable Water Volume
회전방식	Two-Way Rotation
Max Speed	22,000rpm
Air pressure	2.5~2.8kg/cm <sup>2</sup>

■ Korean Distribution | DIO Implant



## Handpiece(High speed handpiece)

### NSK Mach-Lite Type Optic



#### Optic Coupling QC-6M

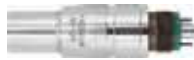

Type	High Speed Turbine-Fiber Optic
Bearing	Ceramic Ball
Speed	340,000~360,000 (rpm)
Burr Install	Push Button
Cooling System	Triple Spray
Weight	57.65 (g)
Head Size	H13.65 (mm) Ø12.49 (mm)
Connector type	Quick Connector 6 holes [compatible with NSK MACH-LITE TYPE]
Bur-holding strength	Above 4.0kg
Brightness	25,000 Lux

■ Korean Distribution | DIO Implant

### NSK Mach-Lite Type Non-Optic



#### Non-Optic Coupling QC-4M



Type	High Speed Turbine-Non Fiber Optic
Bearing	Ceramic Ball
Speed	340,000~360,000 (rpm)
Burr Install	Push Button
Cooling System	Triple Spray
Weight	57.38 (g)
Head Size	H13.65 (mm) Ø12.49 (mm)
Connector type	Quick Connector 4 holes [compatible with NSK MACH-LITE TYPE]
Bur-holding strength	Above 4.0kg

■ Korean Distribution | DIO Implant

### NSK Mach-QD Type Non-Optic



#### Non-Optic Coupling QC-6M



Type	High Speed Turbine-No Fiber Optic
Bearing	Ceramic Ball
Speed	330,000~350,000 (rpm)
Burr Install	Push Button
Cooling System	Triple Spray
Weight	56.7 (g)
Head Size	H:13.7 (mm) Ø:12.40 (mm)
Coupling	Quick Connector 4 holes [Compatible with NSK MACH-QD TYPE]
Bur-holding strength	Above 4.0

■ Korean Distribution | DIO Implant

## Dental Materials

### Dental Materials Beta Cleaner

#### Beta Cleaner-i



#### ■ Features

Biocompatibility consisting of high purity  $\beta$ -TCP  
 Minimized nozzle blocking due to 45 ~ 75 $\mu$ m ball shape  
 Perfect elimination of all inflammations in the micropores on the implant surface  
 Acting as bio carrier for new bone formation after getting rid of inflammation

■ INGREDIENT	$\beta$ -Tricalcium Phosphate
■ average grain size	60 $\mu$ m(45~75 $\mu$ m),
■ Manufactured by	DIO IMPLANT

#### Beta Cleaner-d



#### ■ Features

Simple surgery and immediate effect  
 cheaper than desensitizers on the market  
 Use recommended after scaling and flap surgery  
 Adherence of 20 ~ 45  $\mu$ m ball shaped particles to minute areas  
 facilitation of bone generation by high-purity  $\beta$ -tcp adhering to the exposed dental tubules

■ INGREDIENT	$\beta$ -Tricalcium Phosphate
■ average grain size	35 $\mu$ m(20~45 $\mu$ m)
■ Manufactured by	DIO IMPLANT

## Sterilizers

### Handpiece Sterilizer Dentistar



#### ■ Features

The only one of its kind in the world cleaning, oiling, and lubricating handpieces together with HTOS(High Temperature Oil Sterilization) method.  
 Preventing rust and component damage, and removing residue, thus prolonging handpiece life  
 Preventing cross contamination with perfect sterilization  
 Safe sterilizing oil use approved by FDA and MLHW with no harm to human.

■ Manufactured by | Sejin Medical (Korea)

## Membrane

### Acellular Dermal Matrix SureDerm™



#### ■ Features

Human skin organ  
 Safe  
 Usable to all parts of human body  
 Durable and not susceptible to shrinking

■ Manufactured by | Hans Biomed (Korea)

#### ■ Class

Code	Thickness(mm)	Size(cm)
G102002	0.4~0.59	1X2
G102004		1X4
G102004		2X2
G102008		2X4
G202002	0.6~1.0	1X2
G202004		1X4
G202004		2X2
G202008		2X4

## Bone Material

### Cortical Powder/Chip SureOss



#### ■ Features

Allograft material  
Cortical bone and demineralized bone  
Freeze-dried process for longer shelf life  
Powder type and chip type

■ Manufactured by | Hans Biomed (Korea)

#### ■ Scope of Use

	Osteoconduction	Osteoinduction
Narrow Scope	FDBA/Powder	DFDBA/Powder
Wide Scope	FDBA/Chip	DFDBA/Chip

#### ■ Class

Class	Volume	Size( $\mu\text{m}$ )	Code	
			FDBA	DFDBA
SureOss Powder	0.25cc	200~850	SOP25	DSOP25
	0.5cc		SOP50	DSOP50
	1cc		SOP100	DSOP100
SureOss Chip	0.25cc	850~1,500	SOC25	DSOC25
	0.5cc		SOC50	DSOC50
	1cc		SOC100	DSOC100

### Demineralized Bone Matrix SureFuse II™



#### ■ Features

Demineralized human bone  
Growth factor and protein preserved  
Strong adhesion and simple to use  
Convenient injection type  
Gel type and putty type

■ Manufactured by | Hans Biomed (Korea)

#### ■ Class

Class	Volume	Size( $\mu\text{m}$ )	Code
SureFuse II Gel	0.3cc	150~850	SG03
	0.5cc		SG05
	1cc		SG1
SureFuse II Putty	0.3cc	150~850	SP03
	0.5cc		SP05
	1cc		SP1

### Demineralized Bone Matrix with Cancellous Bone Chip ExFuse™ II



#### ■ Features

Human bone with cancellous bone chip added to demineralized bone  
Strong adhesion and simple to use  
Convenient injection type  
Gel type and putty type

■ Manufactured by | Hans Biomed (Korea)

#### ■ Class

Class	Volume	Size( $\mu\text{m}$ )	Code
ExFuse II Gel	0.3cc	150~850	EG03
	0.5cc		EG05
	1cc		EG1
ExFuse II Putty	0.3cc	150~850	EP03
	0.5cc		EP05
	1cc		EP1

## Toothpaste

### DIO HAp Toothpaste



| 3,57 Oz (100g) | 0,70 Oz (20g)



DIO's premium toothpaste uses only the purest crystalline HAp (Hydroxyapatite)

FDA (USA) approved

- Strengthens enamel
- Effective teeth whitening power
- Superior cavity protection

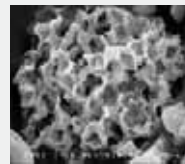

#### Hydroxyapatite

Hydroxyapatite is the main component in bone composition (HAp 60%). HAp repairs and strengthens damaged tooth enamel by bonding with the tooth structure and returning the damaged enamel to its original state. HAp is biocompatible and has no adverse effects on the human body.

### DIO Nano-HAp Toothfoam



| 1,76 Oz (50g) | Refill: 10,56 Oz (300g)



Nano sized HAp toothfoam can be used without a toothbrush (using a toothbrush is highly recommended), while providing superior cleaning power.

FDA (USA) approved

- Strengthens enamel
- Great for use after implant surgery and orthodontics
- Safe and effective after oral surgery



Pump 2-3 times into mouth and rinse for one minute  
Rinse and brush with toothbrush

## Toothpaste

### DIO Toothpaste for children



| 80g, For ages: 2~7



DIO children's toothpaste features HAp and superior cavity protection while providing exceptionally clean teeth.

- Superior Germ Fighting
- Effective Cavity Protection
- Clean Fresh Feeling



#### Mastic

Growing only on its native Greek Island of Kios, the Pistacia Lenticis tree produces a sap that not only contains properties that protect against cavities but also contain anti-microbial properties that provide superior oral protection. From Europe to the rest of the world, we will bring these wonderful properties to your toothpaste.

### DIO HAp PRTC Paste for Dentist



| 1.76 Oz (50g)



DIO PRTC (Professional Re-Enameling Tooth Cleaner) finishing paste provides a strong base for optimal dental health after treatment.

FDA (USA) Approved

- Alleviates tooth sensitivity
- Smoothens rough spots
- Stain prevention
- Strengthens enamel
- Eliminates white spots



Apply PRTC paste using a topical tray.  
After removing tray, completely remove residual paste with 3-way syringe.

## Toothpaste

### ➤ DIO toothpastes alleviates tooth sensitivity

Sensitive teeth alleviation



Tooth sensitivity is generally caused by micro perforations in the enamel. HAp prevents the source of problem by repairing the damaged enamel.

Effective tooth whitening

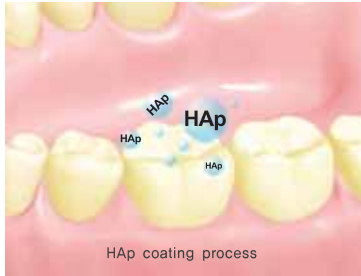

The tooth whitening tooth process does a considerable amount of damage to the tooth enamel, thereby making it susceptible to staining. HAp prevents staining by providing a protective coating, giving the enamel a chance to heal and keep the brightened properties.

Superior cavity protection

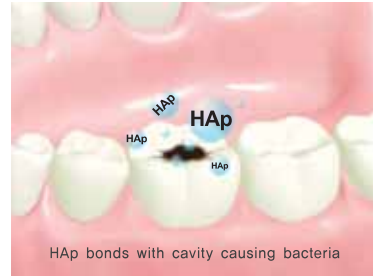

HAp gets to the root of the cause of cavities by bonding with and eliminating the source of infection. The long lasting effects protect teeth enamel and prevent the future cavities.

### ➤ DIO Toothpaste Clinical Studies Data

#### DIO tooth paste whitening effectiveness study

/ Yonsei University

This study concluded that the HAp prevented return of discoloration/staining after whitening treatment.

YUDC, Department of Conservative Dentistry  
/ Yonsei University College of Dentistry 2006



Without HAp application



With HAp application

#### DIO Toothpaste Enamel Repair Effectiveness

/ Gun Yam University

Reference Data: Jun Nam University College of Dentistry 2006

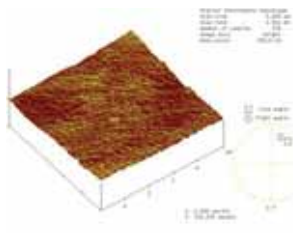

Regular Enamel Level

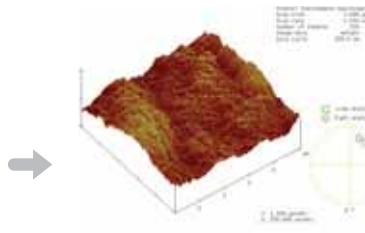

Enamel surface level after whitening treatment

Surface damaged due to process

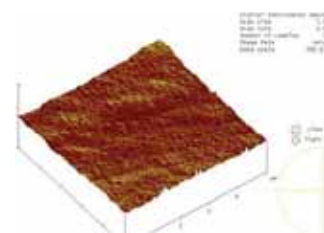

Enamel surface after treatment with DIO toothpaste

Enamel returned to regular level (before whitening treatment)

## Toothpaste

### Tooth sensitivity development after periodontal procedure

/ Yonsei University Professor Jo Gyu Sung

#### Comparison Study

Yonsei University College of Dentistry Hospital patients sample size: 100

Age distribution of Patients

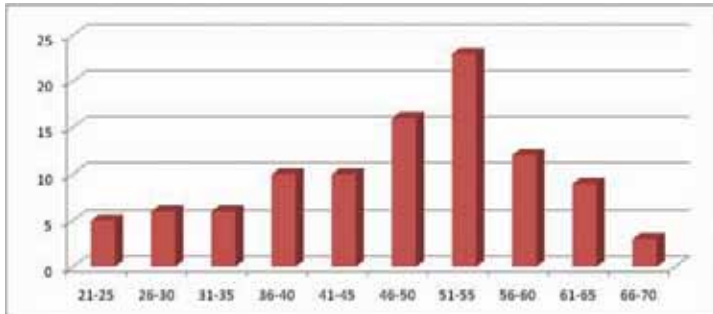

Patients subject to cold test (using ice stick) to measure pain on visual analogue scale (0: No pain – 10: extreme pain) one week and four weeks after treatment

#### Study Results

After conducting a wide variety of tests, the study concluded that toothpastes with Hydroxyapatite were more effective in reducing tooth sensitivity when compared to comparable toothpaste without HAp.

Further clinical studies are recommended to further understand the long term benefits of HAp.

### DIO Toothpaste Benefits

/Kyong Buk University Preventative Dentistry Professor Song Gun Bae

A: No toothpaste application  
 B: Fluoride, Zylatol Toothpaste  
 C: Fluoride, Glycerol Calcium Phosphate Toothpaste  
 D: DIO Toothpaste  
 E: DIO PRTC

#### Electronic Scanning Microscope Image

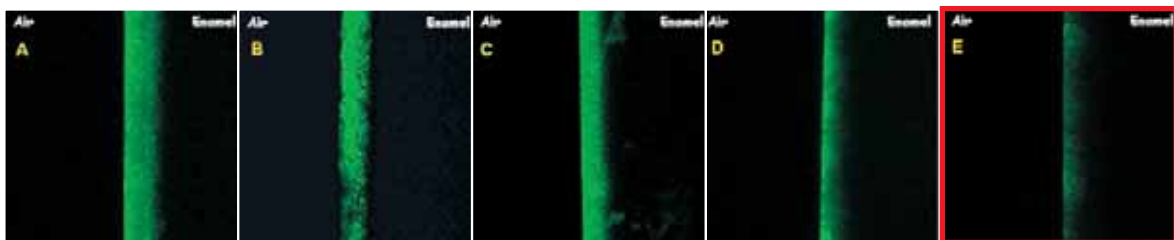

**After 2 Weeks** Utilizing CLSM for initial measurements, mineral losses of 50–60 $\mu$ m were observed in the first group after the first 2 weeks. The second group observed mineral losses of more than 60 $\mu$ m, however some mineral recovery was exhibited under a florescent light (but not conclusively).

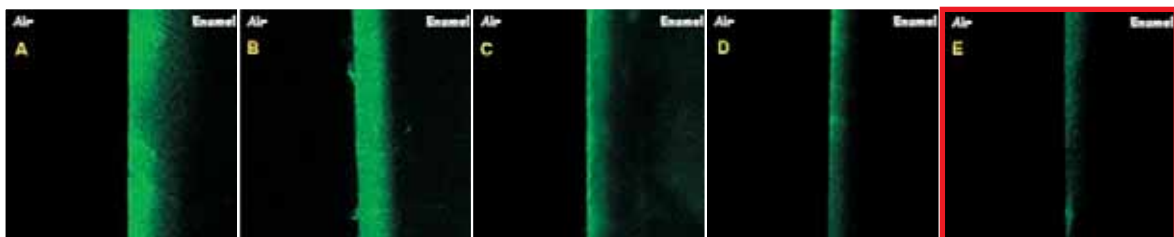

**After 4 Weeks** All groups exhibited some mineral recovery (except for group 1), however, the outcome of groups 2–5 were successively more apparent with group 5 exhibiting the most mineral recovery. The report concludes that group 5 was clearly the most successful out of the groups tested.

# Global Business Network

Exports over 50 countries

  
 Branch (6)    ● Distributor



#5k Rimco bldg, 139 Soi Sukhumvit 63,  
 Klongtan Nua, Wattana, Bangkok 10110  
 Tel. +66 2 714 7875  
 Fax. +66 2 714 7744



Tecasin Room 112, 243-243B Hoang Van Thu St.,  
 Tan Binh District, Ho Chi Minh City, SR Vietnam  
 Tel. +84 8 3997 4878  
 Fax. +84 8 3997 4895



No.538,603 Building,Wangjingyuan,  
 Chaoyang District,Beijing  
 Tel. + 86 010 8478 7353  
 + 86 010 8478 7363  
 Fax. + 86 010 8478 7353



RM 302 No.1339 Wuzhong Rd,Minhang  
 District,ShangHai China  
 TEL.+86 21 3431 9504  
 FAX.+86 21 3431 9604



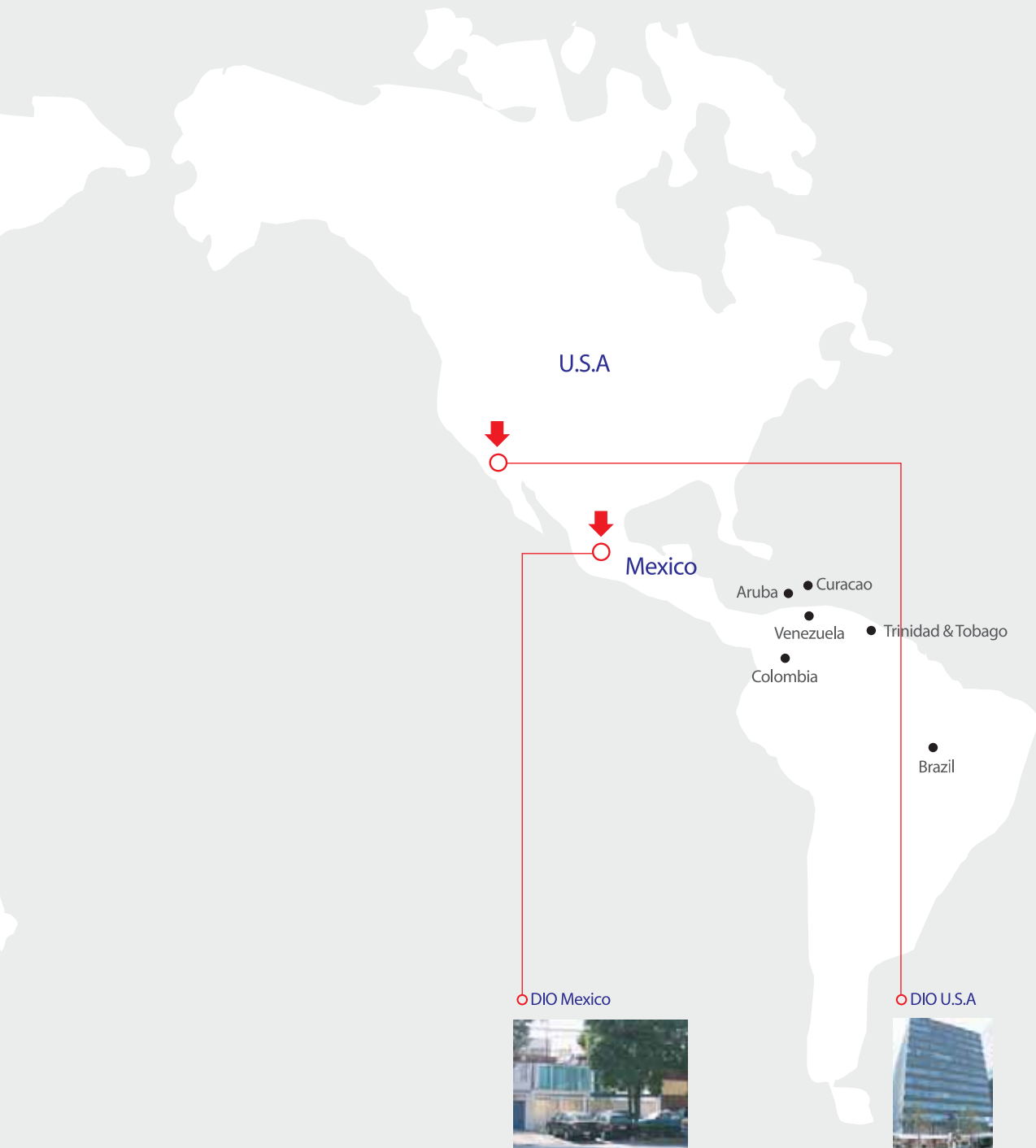

U.S.A

Mexico

Aruba • Curacao  
Venezuela • Trinidad & Tobago  
Colombia  
Brazil

○ DIO Mexico

○ DIO U.S.A



Obrero Mundial N.919 Col. Alamos  
C.P.03400, Mexico D.F. Mexico  
Tel. +52 55 4439 2656



3540 Wilshire Blvd #1104, Los Angeles, CA 90010, USA  
Tel. +1 213 365 2875  
Fax. +1 213 365 1595

# Memo

A series of horizontal dashed lines for writing.

# Memo

A series of horizontal dotted lines for writing.

